

User Manual

# XGT Panel



## Safety Instructions

- Read this manual carefully before installing, wiring, operating, servicing or inspecting this equipment.
- Keep this manual within easy reach for quick reference.

# Contents

## Chapter 1. General

- 1.1 Guide to Use This Manual..... 1 - 1
- 1.2 Features..... 1 - 2
  - 1.2.1 Features of XGT Panel ..... 1 - 2

## Chapter 2. Names of Parts

- 2.1 Names of Parts and Description ..... 2 - 1

## Chapter 3. General Specifications

- 3.1 General Specifications ..... 3 - 1
- 3.2 Performance Specifications ..... 3 - 2

## Chapter 4. System Configurations

- 4.1 1:1 Configuration..... 4 - 1
- 4.2 1:N Configuration ..... 4 - 2
- 4.3 N:1 Configuration..... 4 - 3
- 4.4 N:M Configuration ..... 4 - 4
- 4.5 Slave Configuration..... 4 - 5

## Chapter 5. Panel Editor Installation

- 5.1 System Requirements..... 5 - 1
- 5.2 Panel Editor Installation ..... 5 - 2
  - 5.2.1 Panel Editor Installation Procedure ..... 5 - 2

## Chapter 6. Panel Editor

- 6.1 Main Screen of Panel Editor ..... 6 - 1
  - 6.1.1 Project Window ..... 6 - 2
  - 6.1.2 Screen Edit Window..... 6 - 3
  - 6.1.3 Toolbar ..... 6 - 4
  - 6.1.4 Menu ..... 6 - 4
- 6.2 Project Window ..... 6 - 5
  - 6.2.1 Project Window Tree..... 6 - 5
  - 6.2.2 Edit Project Window..... 6 - 5
- 6.3 Screen Edit Window..... 6 - 8
  - 6.3.1 Screen Edit Window..... 6 - 8

6.4 Menu & Toolbar .....	6 - 12
6.4.1 Menus .....	6 - 12
6.4.2 Toolbar .....	6 - 15
6.5 Project Menu .....	6 - 18
6.5.1 New Project .....	6 - 18
6.5.2 Open Project .....	6 - 27
6.5.3 Save Project .....	6 - 27
6.5.4 Save As .....	6 - 27
6.5.5 Change PLC Type .....	6 - 27
6.5.6 Change COM Port .....	6 - 28
6.5.7 Print .....	6 - 28
6.5.8 Print Preview .....	6 - 29
6.5.9 Recent File .....	6 - 29
6.5.10 Exit .....	6 - 29
6.6 Edit Menu .....	6 - 30
6.6.1 Cut .....	6 - 30
6.6.2 Copy .....	6 - 30
6.6.3 Paste .....	6 - 30
6.6.4 Delete .....	6 - 30
6.6.5 Order .....	6 - 30
6.6.6 Align / Space .....	6 - 31
6.6.7 Grid & Snap .....	6 - 34
6.6.8 Select All .....	6 - 35
6.6.9 Lock Tag .....	6 - 35
6.6.10 Unlock Tag .....	6 - 35
6.6.11 Pop-up Menu .....	6 - 35
6.7 View Menu .....	6 - 36
6.7.1 Status Bar .....	6 - 36
6.7.2 Memory Usage .....	6 - 36
6.7.3 System Memory Usage .....	6 - 37
6.7.4 Zoom Box .....	6 - 37
6.8 Screen Menu .....	6 - 38
6.8.1 New Screen .....	6 - 38
6.8.2 Delete Screen .....	6 - 38
6.8.3 Screen Property .....	6 - 39
6.8.4 Tag List .....	6 - 39
6.8.5 Function Key List .....	6 - 40

6.9 Tag Menu .....	6 - 41
6.9.1 Numeric Tag .....	6 - 41
6.9.2 Message Tag .....	6 - 49
6.9.3 Button Tag .....	6 - 52
6.9.4 Lamp Tag .....	6 - 55
6.9.5 Bar Graph Tag .....	6 - 56
6.9.6 Trend Graph Tag .....	6 - 58
6.9.7 Pie Graph Tag .....	6 - 60
6.9.8 Rotation Tag .....	6 - 64
6.9.9 Move Tag .....	6 - 66
6.9.10 Clock Tag .....	6 - 68
6.10 Draw Menu .....	6 - 70
6.10.1 Selection .....	6 - 70
6.10.2 Text .....	6 - 70
6.10.3 Image Text .....	6 - 71
6.10.4 Image .....	6 - 73
6.10.5 Line .....	6 - 74
6.10.6 Rect .....	6 - 75
6.10.7 Circle .....	6 - 76
6.11 Common Resource Menu .....	6 - 77
6.11.1 Message .....	6 - 77
6.11.2 Image .....	6 - 77
6.11.3 Parameter .....	6 - 78
6.11.4 Alarm .....	6 - 79
6.11.5 Calculation .....	6 - 81
6.11.6 Block Communication .....	6 - 83
6.11.7 Reservation .....	6 - 85
6.12 Communication Menu .....	6 - 88
6.12.1 Download / Upload .....	6 - 88
6.12.2 Font .....	6 - 89
6.12.3 Data / Time .....	6 - 89
6.12.4 Password .....	6 - 90
6.12.5 Clear Password .....	6 - 90
6.12.6 Entire Memory Format .....	6 - 91
6.12.7 O/S Download .....	6 - 91
6.12.8 Read Alarm History .....	6 - 93
6.12.9 Delete Alarm History .....	6 - 96
6.12.10 Read System Information .....	6 - 96

6.13 Tools	6 - 97
6.13.1 Customize Toolbars	6 - 97
6.13.2 Customize Shortcut Keys	6 - 100
6.13.3 Option	6 - 101
6.14 Window	6 - 102
6.14.1 Cascade Mode	6 - 102
6.14.2 Tile Mode	6 - 103
6.14.3 Arrange Icons	6 - 103
6.14.4 Close All	6 - 103
6.15 Help	6 - 104
6.15.1 About Panel Editor	6 - 104
6.16 Function Key Settings	6 - 105
6.16.1 None	6 - 106
6.16.2 Bit	6 - 106
6.16.3 Drive out	6 - 107
6.16.4 Increment	6 - 108
6.16.5 Decrement	6 - 109
6.16.6 Screen	6 - 110

## Chapter 7. XGT Panel Function

7.1 Key Operation	7 - 1
7.1.1 Operation Mode	7 - 1
7.1.2 Screen Change Mode	7 - 1
7.1.3 Alarm History Mode	7 - 2
7.1.4 XGT Panel System Menu Mode	7 - 3
7.2 Operation Mode	7 - 9
7.2.1 Monitoring mode	7 - 9
7.2.2 Key	7 - 11
7.3 Changing Screen	7 - 12
7.3.1 By Function Keys	7 - 12
7.3.2 From the Screen List	7 - 12
7.3.3 Bu Screen Saver	7 - 12
7.3.4 By Online Screen Change	7 - 12
7.4 Alarm	7 - 13
7.4.1 Alarm Message	7 - 13
7.4.2 Alarm Buzzer	7 - 13
7.4.3 Alarm History	7 - 13
7.5 Buzzer	7 - 14
7.5.1 Buzzer Operation	7 - 14
7.6 System Memory	7 - 14

## Chapter 8. Communication

8.1 Drive Download.....	8 – 1
8.2 LS MASTER-K Series Loader Protocol.....	8 – 2
8.2.1 Communication Mode.....	8 - 2
8.2.2 Connection Available Device .....	8 - 2
8.2.3 Connection Diagram .....	8 - 3
8.3 LS MASTER-K Series : Dedicated Protocol.....	8 – 4
8.3.1 Communication Mode.....	8 - 4
8.3.2 Connection Available Device .....	8 - 4
8.3.3 Connection Diagram .....	8 - 5
8.4 LS MASTER-K 10S1 : Dedicated Protocol .....	8 – 6
8.4.1 Communication Mode.....	8 - 6
8.4.2 Connection Available Device .....	8 - 6
8.4.3 Connection Diagram .....	8 - 7
8.5 LS MASTER-K Series : Dedicated Protocol.....	8 – 8
8.5.1 Communication Mode.....	8 - 8
8.5.2 Connection Available Device .....	8 - 8
8.5.3 Connection Diagram .....	8 - 9
8.6 LS MASTER-K 500H/1000H : Dedicated Protocol.....	8 – 10
8.6.1 Communication Mode.....	8 - 10
8.6.2 Connection Available Device .....	8 - 10
8.6.3 Connection Diagram .....	8 - 11
8.7 LS GLOFA GM Series : Loader Protocol.....	8 – 12
8.7.1 Communication Mode.....	8 - 12
8.7.2 Connection Available Device .....	8 - 12
8.7.3 Connection Diagram .....	8 - 13
8.8 LS GLOFA GM Series : Dedicated Protocol.....	8 – 14
8.8.1 Communication Mode.....	8 - 14
8.8.2 Connection Available Device .....	8 - 14
8.8.3 Connection Diagram .....	8 - 15
8.9 LS Inverter : Dedicated Protocol .....	8 – 16
8.9.1 Communication Mode.....	8 - 16
8.9.2 Connection Available Device .....	8 - 16
8.9.3 Connection Diagram .....	8 - 17

8.10 MODBUS Protocol .....	8 – 18
8.10.1 Communication Mode .....	8 - 18
8.10.2 Connection Available Device .....	8 - 18
8.10.3 Connection Diagram .....	8 - 19
8.11 Mitsubishi Melsec FX Series : Link Protocol.....	8 – 20
8.11.1 Communication Mode .....	8 - 20
8.11.2 Connection Available Device.....	8 - 20
8.11.3 Connection Diagram .....	8 - 21
8.12 OMRON CPM : C-Mode Protocol .....	8 – 22
8.12.1 Communication Mode .....	8 - 22
8.12.2 Connection Available Device .....	8 - 22
8.12.3 Connection Diagram .....	8 - 23
8.13 Koyo Direct Logic 06 : DirectNet .....	8 – 24
8.13.1 Communication Mode .....	8 - 24
8.13.2 Connection Available Device .....	8 - 24
8.13.3 Connection Diagram .....	8 - 25
8.14 NAIS FP Series : Mewtocol.....	8 – 26
8.14.1 Communication Mode .....	8 - 26
8.14.2 Connection Available Device .....	8 - 26
8.14.3 Connection Diagram .....	8 - 27
8.15 Simens S7-200 Series : PPI Protocol .....	8 – 28
8.15.1 Communication Mode .....	8 - 28
8.15.2 Connection Available Device .....	8 - 28
8.15.3 Connection Diagram .....	8 - 29
8.16 Fuji Inverter FVR-E11S .....	8 – 30
8.16.1 Communication Mode .....	8 - 30
8.16.2 Connection Available Device .....	8 - 30
8.16.3 Connection Diagram .....	8 - 31

## **Chapter 9. Installation and Wiring**

9.1 Installation.....	9 – 1
9.1.1 Installation Environment.....	9 - 1
9.1.2 Handling Instructions .....	9 - 2
9.2 Wiring.....	9 – 4
9.2.1 Power Supply Wiring.....	9 - 4
9.2.2 Cable Specifications for Wiring .....	9 - 5

## **Chapter 10. Maintenance**

10.1 Maintenance and Inspection .....	10 – 1
10.2 Daily Inspection.....	10 – 1
10.3 Periodic Inspection.....	10 – 2

## **Appendix**

Appendix 1 System Memory .....	App-1
Appendix 2 Dimension .....	App-3
Appendix 2.1 External Dimension.....	App-3
Appendix 2.2 Cutting Dimension.....	App-3



# Chapter 1. General

## 1.1 Guide to Use This Manual

This manual includes specifications, functions and handling instructions for the XGT Panel.

This manual is divided up into chapters as follows:

No.	Title	Contents
Chapter 1	General	Describes configuration of this manual, unit's features and terminology.
Chapter 2	Names of Parts	Describes each kind of manufacturing goods, titles, and main functions.
Chapter 3	General Specifications	Describes general specifications of the XGT Panel.
Chapter 4	System Configuration	Describes system configurations in the XGT Panel.
Chapter 5	Panel Editor Installation	Describes installation of Panel Editor.
Chapter 6	Panel Editor	Describes function of Panel Editor.
Chapter 7	XGT Panel Function	Describes function of XGT Panel.
Chapter 8	Communication Specification	Describes communication specification.
Appendix 1	System Memory	Describes system memory.
Appendix 2	Dimensions	Shows dimensions of XGT Panel.

### 1.2. Features

#### 1.2.1 Features of XGT Panel

- (1) Increased application design flexibility through wide graphic LCD (192× 64 dot)
- (2) Slim design which considers a user's convenience
- (3) Supports two communication channels independently (RS-232C, RS-422/485),  
(supporting N:M communication)
- (4) Built-in 512K bytes Flash-Memory
- (5) O/S and font download system for an upgrade
- (6) Provides various tags and drawing functions
- (7) Supports multi-languages: Korean, English, Chinese, Russian and others will be provided hereafter
- (8) Provides Window-based monitoring software (Panel Editor)
- (9) Provides 1000 words of system memory area
- (10) 2 kinds of power supply:
  - You can connect the external 24VDC through a power supply terminal.
  - The 5VDC power can be supplied directly through a communication port (RS-232C)(Available on LS PLC)
- (11) Supports very high communication speed (maximum of 115,200 bps, HEX communication)
  - Improved up/download speed
- (12) Provides user defined function keys for each screen: F1-F4, ▲, ▼, ◀, ▶
- (13) Provides built-in RTC function (available on XP10KB/DC only)
- (14) Each memory area can be up/downloaded in part
- (15) Supports two kinds of password (for up · downloading/ data writing)
- (16) Supports user defined bitmap input function
- (17) Supports bitmap text in various fonts and sizes
- (18) Provides various communication drivers

## Chapter 2. Names of Parts

### 2.1 Names of Parts and Description

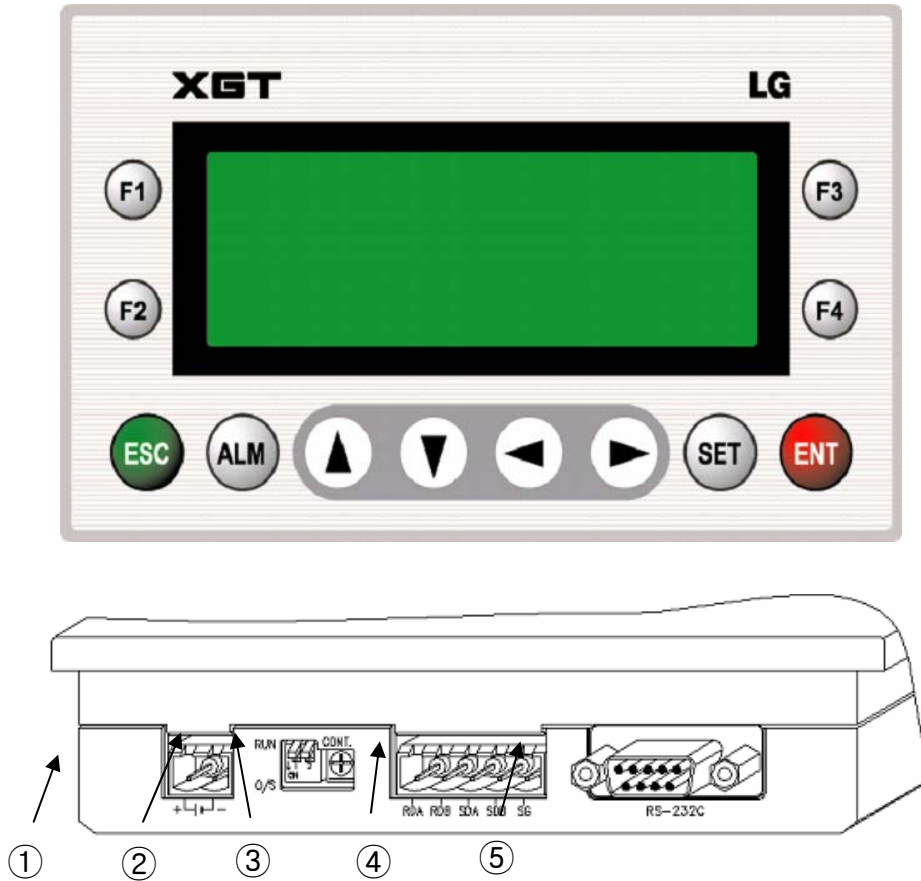

No	Names	Description	Remark
1	Power supply connector	Supplies power to the XGT Panel.	24VDC
2	O/S download switch	Switch for OS downloading Place the switch to the 'RUN' position.	Default: RUN
3	Variable resistance for brightness control	Adjusts the brightness of the XGT Panel.	
4	RS-422/485 connector	Connects to the RS-422/485.	
5	RS-232C connector	Connects to the RS-232C.	DC 5V

# Chapter 3. General Specifications

## 3.1 General Specifications

The following table shows the general specifications of the XGT Panel.

No.	Item	Specifications	References				
1	Operating ambient temperature	0 ~ 40 °C					
2	Storage ambient temperature	-10 ~ +50 °C					
3	Operating ambient humidity	5 ~ 95%RH, non-condensing					
4	Storage ambient humidity	5 ~ 95%RH, non-condensing					
5	Vibrations	Occasional vibration		-	IEC 61131-2		
		Frequency	Acceleration	Amplitude		Sweep count	
		10 ≤ f < 57Hz	-	0.075mm			
		57 ≤ f ≤ 150Hz	9.8m/s <sup>2</sup> {1G}	-			
		Continuous vibration		10 times for each X, Y, Z axis		IEC 61131-2	
		Frequency	Acceleration				Amplitude
		10 ≤ f < 57Hz	-				0.0375mm
		57 ≤ f ≤ 150Hz	4.9m/s <sup>2</sup> {0.5G}	-			
6	Shocks	<ul style="list-style-type: none"> <li>Maximum shock acceleration: 147 m/s<sup>2</sup> {15G}</li> <li>Duration time: 11ms</li> <li>Pulse wave: half sine pulse (3 shocks per axis, on X, Y, Z axis)</li> </ul>	IEC 61131-2				
7	Noise immunity	Square wave Impulse noise	± 500 V	LSIS' Standard			
		Electronic discharge	Voltage: 4 kV (Discharge by contact)		IEC 61131-2, IEC 61000-4-2		
		Radiated electromagnetic field noise	27 ~ 500 MHz, 10 V/m		IEC 61131-2, IEC 61000-4-3		
		Fast transient & Burst noise	Voltage	1kV / 0.25kV	IEC 61131-2 IEC 61000-4-4		
8	Atmosphere	Free of corrosive gases and excessive dust					
9	Altitude	Up to 2,000m					
10	Pollution degree	2					
11	Cooling method	Air-cooling					

### REMARK

1) IEC (International Electro-technical Commission): An international civilian institute who establishes international standards in electronics.

2) Pollution degree: An indicator which determines the insulation performance of the equipment.

\* Pollution degree 2: Normally, only non-conductive pollution occurs. Occasionally however, a temporary conductivity caused by condensation may be expected

## Chapter 3. General Specifications

### 3.2 Performance Specifications

The following table shows the performance specifications of the XGT Panel

Item		Specifications		References
		XP10BKA/DC	XP10BKB/DC	
Input voltage	5VDC	DC 4.9 ~ 5.1 (RS-232C port)		
	24VDC	DC 21.6 ~ 26.4 (DC Input connector)		
	Consumption current	Less than 200mA		
Display		LED back-light (192 x 64 Dots)		
Communication interface		RS-232C, RS-422/485		Can be used independently
Flash memory		256K bytes		
Language		Default: English, Can be switched to Korean/Chinese/Russian		
RTC		None	Supports	
Download specification		115,200bps		
Keys		12 Keys (F1~f4, ESC, ALM, ▲, ▼, ◀, ▶, SET, ENT)		
System memory	System area	S000 ~ S899 (900 Word)		Latch area setting available for XP10BKB/DC type
	System flag	S900 ~ S999 (100 Word)		

## Chapter 4. System Configurations

XGT Panel provides two individual communication channels (RS-232C, RS-422/485), so it can be connected to the various type of devices.

This section describes the outline of communication system of the XGT Panel series.

### 4.1 1:1 Configuration

The 1:1 communication system using XGT Panel can be configured as shown below.  
In this case, XGT Panel is a master and the others are slaves.

- Communications channel 1 (RS-232C) links to the LS MASTER-K120S via LS MK Loader protocol.
- Communications channel 2 (RS-485) links to the LS inverter via LS Inverter dedicated protocol.

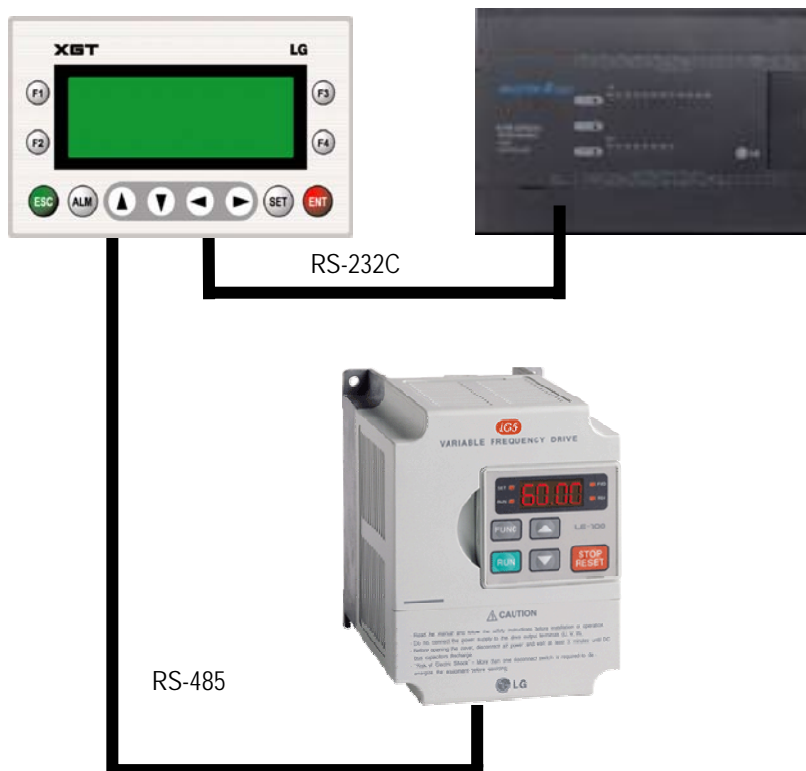

Channel	Protocol	Device	Communication	Remark
Ch 1(RS-232C)	LS:MASTER-K (Loader)	MASTER-K120S	1:1	
Ch 2(RS-485)	LS: Inverter	LS Inverter IG-5	1:1	

# Chapter 4. System Configurations

## 4.2 1:N Configuration

The 1:N multi-drop communication system using XGT Panel can be configured as shown below via communication channel 2 (RS-422/485). In this case, up to 32 stations (0-31) are available including XGT Panel.

The following shows examples of 1:N communication systems using XGT Panel.

1) 1:N multi-communication system via communication channel 2 (RS-485)

(1) In this case, XGT Panel is a master and the several LS MASTER-K120S are slaves.

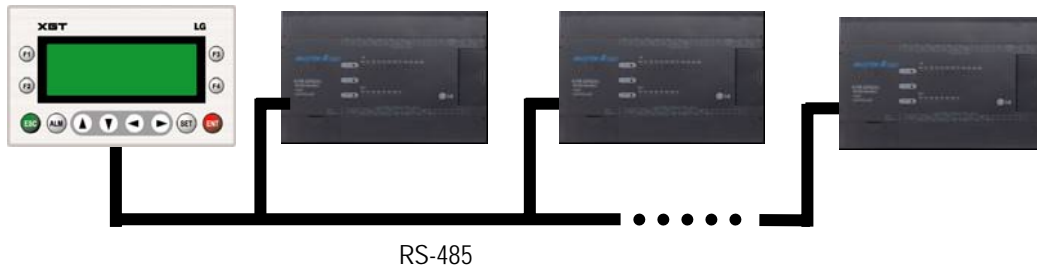

Channel	Protocol	Device	Communication	Remark
Ch 1(RS-232C)	Not used	-	-	
Ch 2(RS-485)	LS:MASTER-K(Link)	LS MASTER-K120S	1:N	

2) 1:1 and 1:N individual communication system configuration via Ch. 1(RS-232C) and Ch.2 (RS-485)

- (1) Connect to the LS MASTER-K120S via communication channel 1(RS-232C) using LS MK Loader protocol.
- (2) Establish 1:N communication system via communication channel 2 (RS-485) using LS inverter-dedicated protocol.

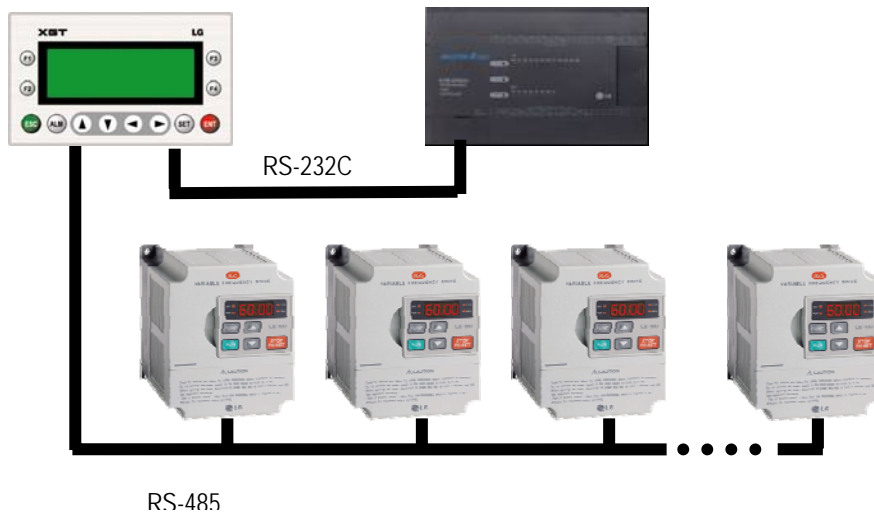

Channel	Protocol	Device	Communication	Remark
Ch 1(RS-232C)	LS: MASTER-K(Loader)	MASTER-K120S	1:1	
Ch 2(RS-485)	LS: Inverter	LS MASTER-K120S	1:N	

## Chapter 4. System Configurations

### 4.3 N:1 Configuration

This is the example that many XGT Panels control one slave as a multiple-master (available on RS-422/485 only). Up to 32 stations (station 0 ~ station 31) including the XGT Panel are available, and the example of the N:1 communication system is shown below.

- 1) N:1 Multi-communication system using the communication channel 2 (RS-485)
  - Multi-master controls 1 slave, MASTER-K120S.

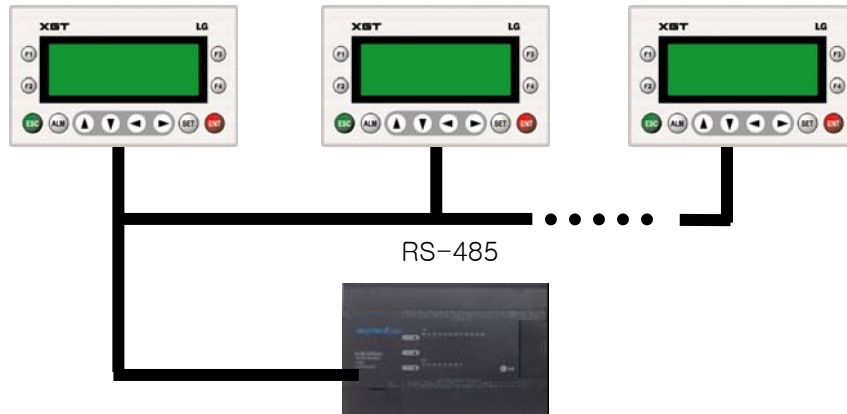

Channel	Protocol	Device	Communication	Remark
Ch 1(RS-232C)	Not used	-	-	
Ch 2(RS-485)	LS: MASTER-K(Link)	LS MASTER-K120S	N:1	



## Chapter 4. System Configurations

### 4.4 N:M Configuration

This is the example that many XGT Panels control many slaves as a multiple-master (available on RS-422/485 only) and it enables the N:M communication system.

Up to 32 stations (station 0 ~ station 31) including the XGT Panel are available, and the example of the N:M communication system is shown below. (The maximum number of the stations can be changed following the device.)

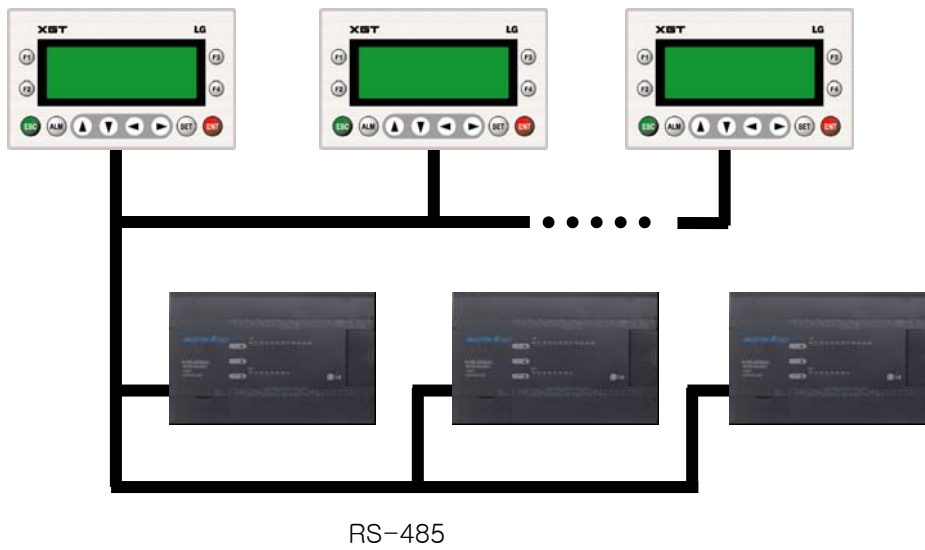

Channel	Protocol	Device	Communication	Remark
Ch 1(RS-232C)	Not used	-	-	
Ch 2(RS-485)	LS:MASTER-K(Link)	LS MASTER-K120S	N:M	

## Chapter 4. System Configurations

### 4.5 Slave Configuration

XGT Panel can be used as a slave, and LS: MASTER-K (Link) and Modbus (RTU, ASC) communication protocols are only available. In this case, the master of the system can read and write the system memory area (S0 ~ S999) of the XGT Panel.

Channel 1 and channel 2 of the XGT Panel are used individually, so it is possible that the one channel can be used for the master and the other channel for a slave. In some cases, both of the channels can be used for a slave.

This is the example that the XGT Panel is used as a slave.

- Channel 1: LS MASTER-K120S is the master and the LS:MASTER-K(Link) protocol is used to connect to the XGT Panel.
- Channel 2: LS MASTER-K120S is the master and the MODBUS(RTU) protocol is used to connect to the XGT Panel.

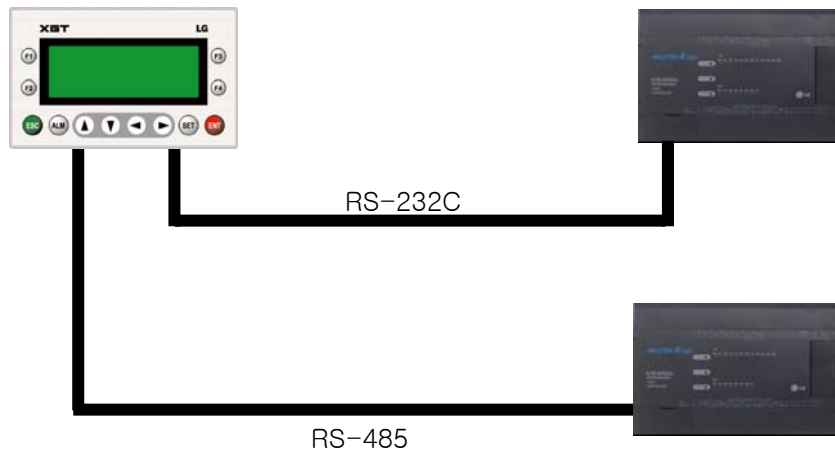

Channel	Protocol	Device	Communication	Remark
Ch 1(RS-232C)	LS:MASTER-K(Link)	LS MASTER-K120S	Slave	
Ch 2(RS-485)	MODBUS(RTU)	LS MASTER-K120S	Slave	

# Chapter 5. Panel Editor Installation

## 5.1 System Requirements

Panel Editor can be used with IBM-compatible PCs. The following hardware and software are required for the successful installation for Panel Editor.

Item	Recommended System Requirements
CPU	IBM PC Compatible MMX 233, Celeron or higher recommended
RAM	64 M bytes of RAM (128 M bytes recommended)
Hard disk drive	20 M bytes of free disk of hard disk drive
Serial port	Serial communication port 1 or more (used for data communication with XGT Panel)
Monitor	Super SVGA monitor (screen resolution at least 800 x 600, 256 colors. 1024X768 or higher recommended)
Keyboard	Windows compatible keyboard
Mouse	Windows compatible mouse
Printer	Windows compatible printer
Recommended OS version	Windows 98, Windows NT4.0 (Intel) with Service Pack 6 or later, Windows 2000 Professional, or Windows /XP

### REMARK

- 1) The Panel Editor cannot be executed if the specifications do not meet the recommended system requirements.

## Chapter 5. Panel Editor Installation

---

### 5.2 Panel Editor Installation

#### 5.2.1 Panel Editor Installation Procedure

This Installation procedure is the same in Windows 98/NT4.0/2000/XP.

- 1) Execute XGT Editor Setup (English).exe.

Installation Wizard window appears as shown below. Click **Next**.

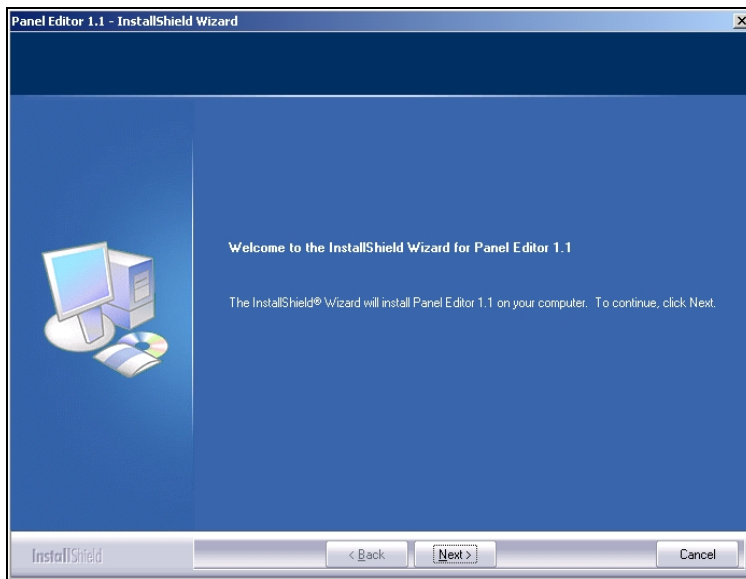

- 2) Customer Information window appears as shown below.

Enter your name and the name of the company and then click **Next**.

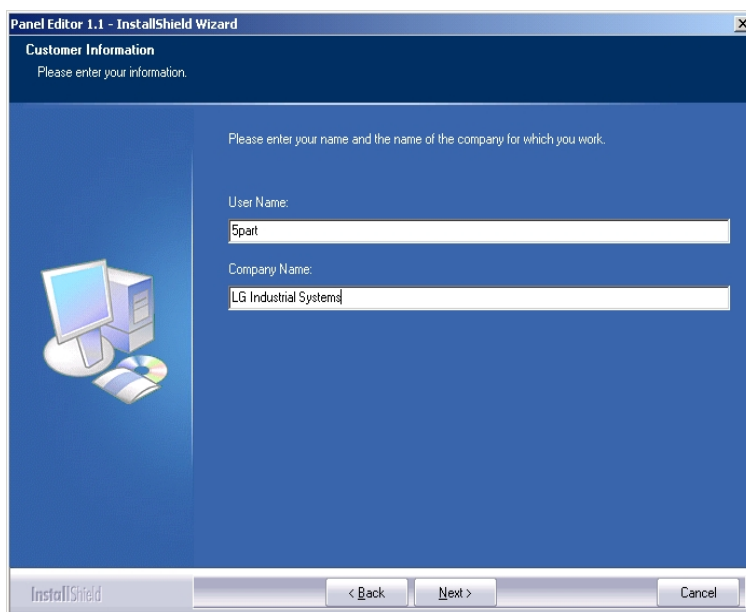

## Chapter 5. Panel Editor Installation

---

3) Choose Folder window appears as shown below.

(1) Select the directory and click **OK**.

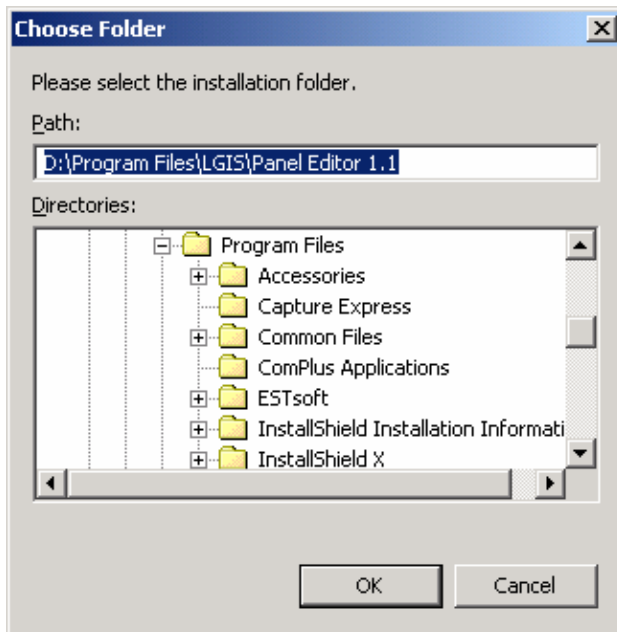

(2) To continue, click **Next**.

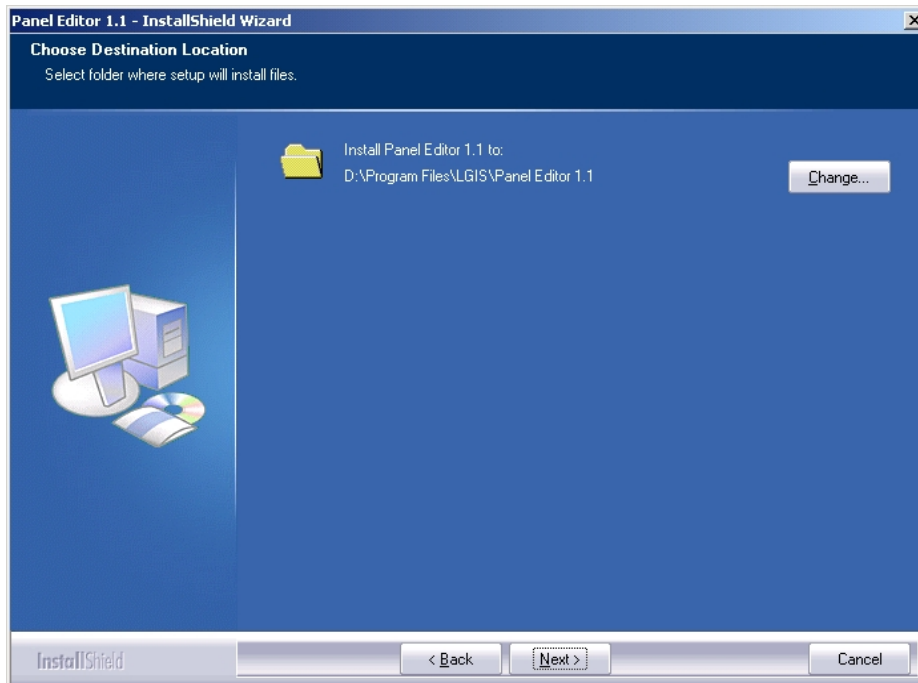

## Chapter 5. Panel Editor Installation

---

4) Ready to Install the Program window appears as shown below. Click **Install**.

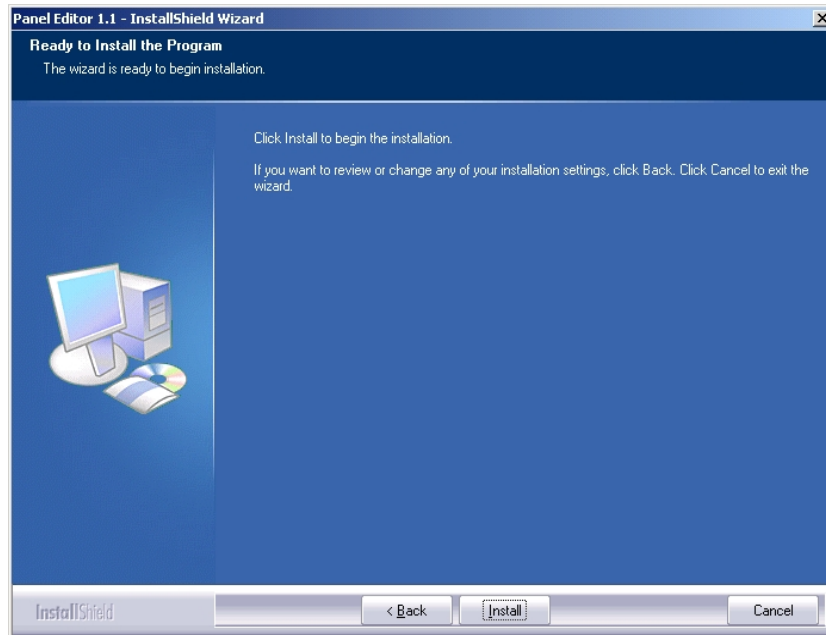

5) Setup Status dialog box appears as shown below, and the installation starts.

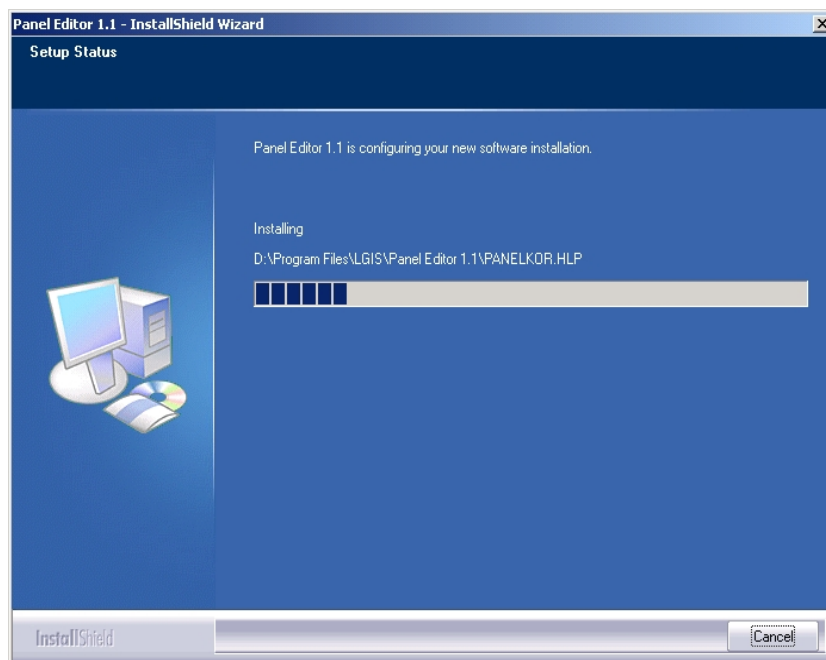

## Chapter 5. Panel Editor Installation

---

6) The InstallShield Wizard Complete window appears as shown below.

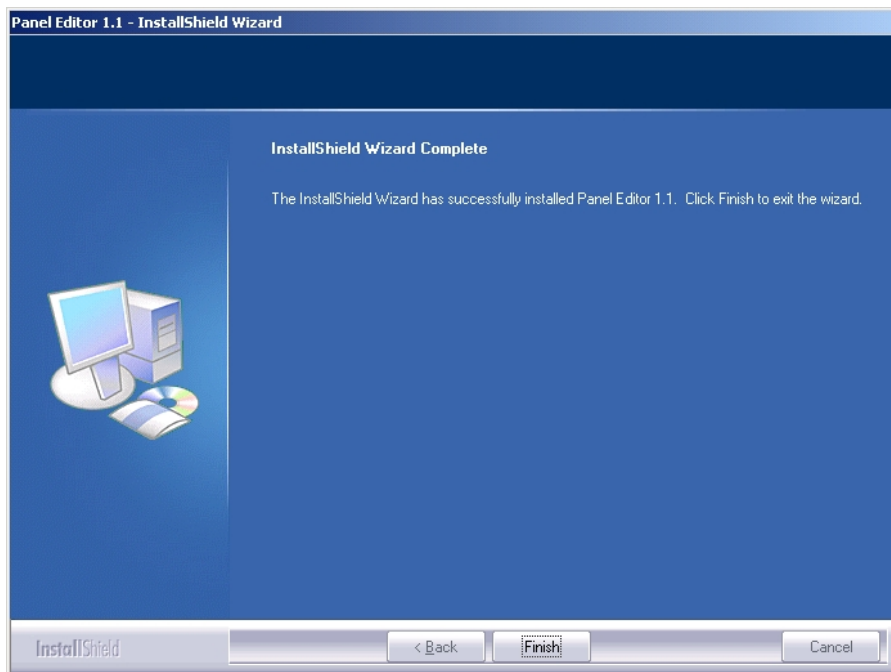

Click **Finish**, and then the installation is completed.

7) Shortcuts are created in the desktop and the Start -> Program -> LGIS -> Panel Editor folder.

## Chapter 6. Panel Editor

### 6.1 Main Screen of Panel Editor

The Panel Editor consists of three windows and their function's are as follows.

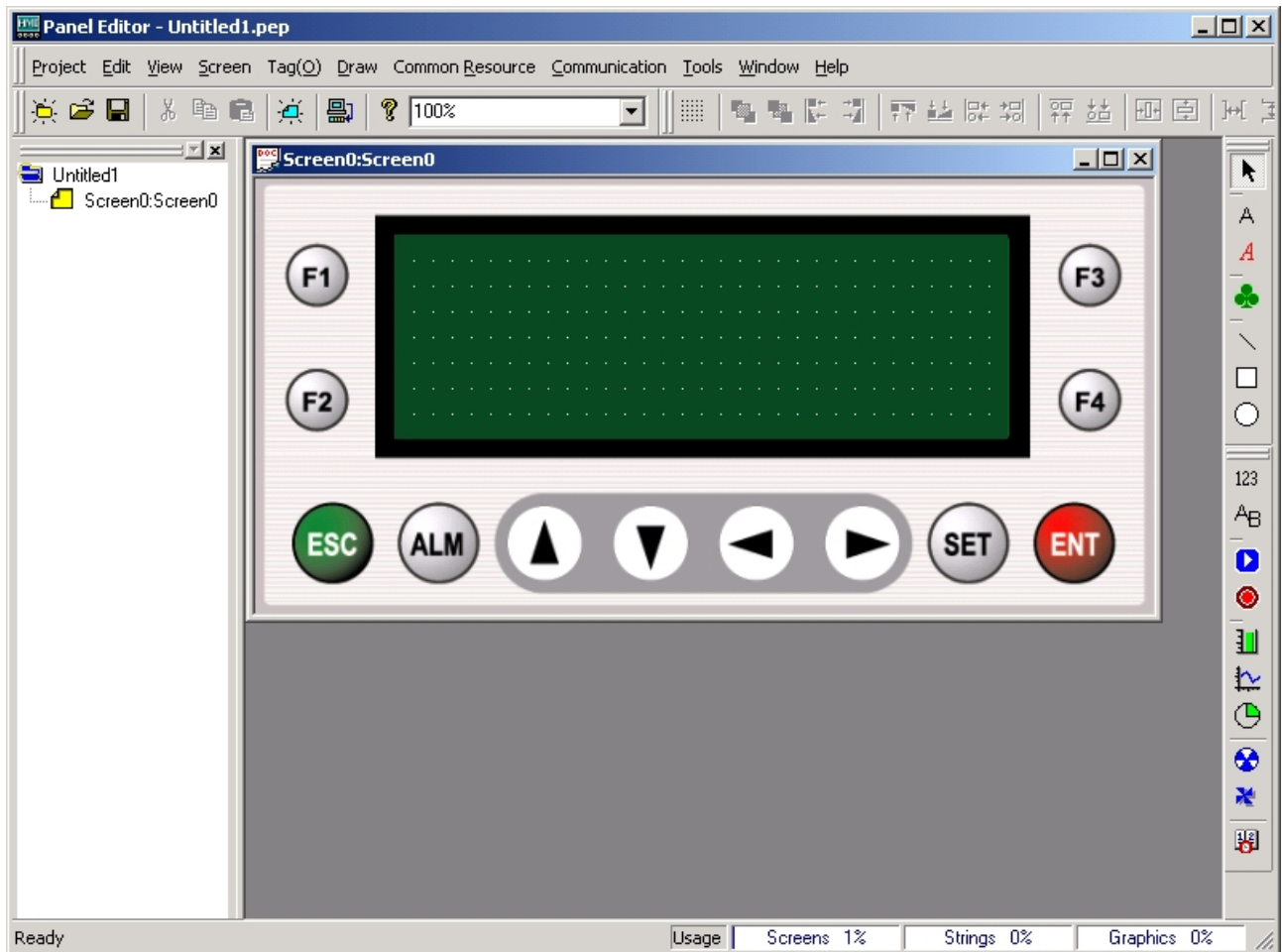

Item	Description	Remark
Project window	Displays the active project and the screen list.	
Toolbar	Shows various tags and tools.	
Screen Edit Window	Displays the active window.	
Menu	Displays File, Edit, View, Screen Tag, Draw, Common Resource, Communication, Tools, Window, Help menu.	



## Chapter 6. Panel Editor

### 6.1.1 Project Window

- 1) Displays the current project and the list of screens.
- 2) Displays the screen number and name that are included to the project.  
'Copy', 'Paste' and 'Delete' are available in this window, but if there is only one screen left, the last screen cannot be deleted.
- 3) The project window is displayed left end, and it can be split and put together in new arrangements.
- 4) If the item is selected in the project window, the screen to be edited is displayed in the Screen Edit Window.

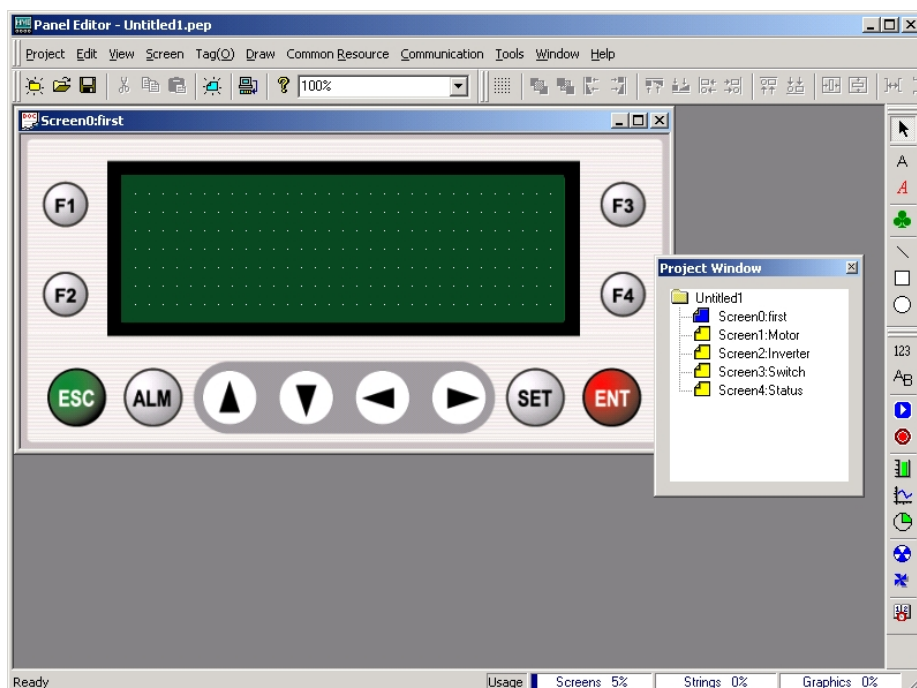
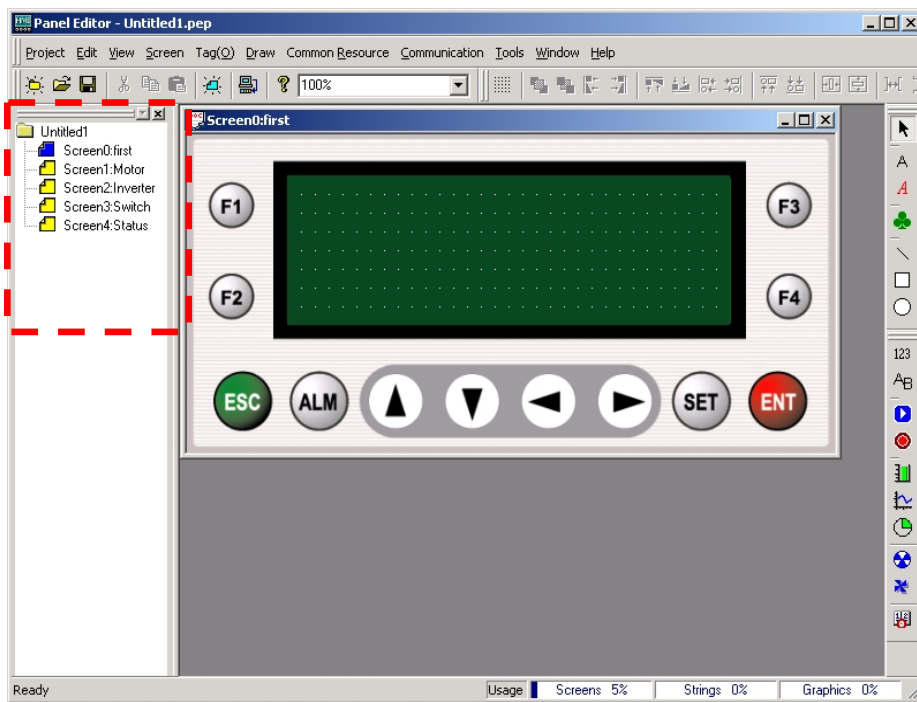

## Chapter 6. Panel Editor

### 6.1.2 Screen Edit Window

- 1) Displays the screen creation windows, and many screens can be edited at the same time.

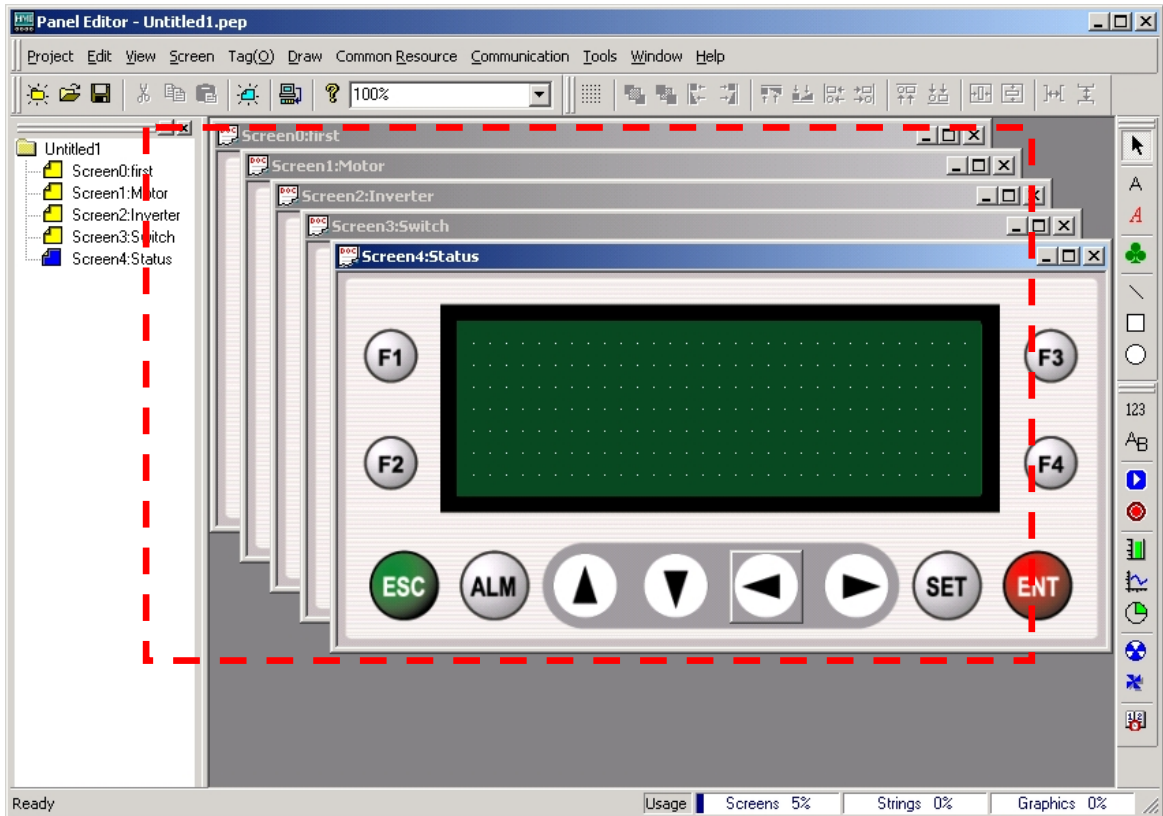

- 2) When the screen creation window is selected, the screen property window shown in below is displayed to set the properties for each screen.

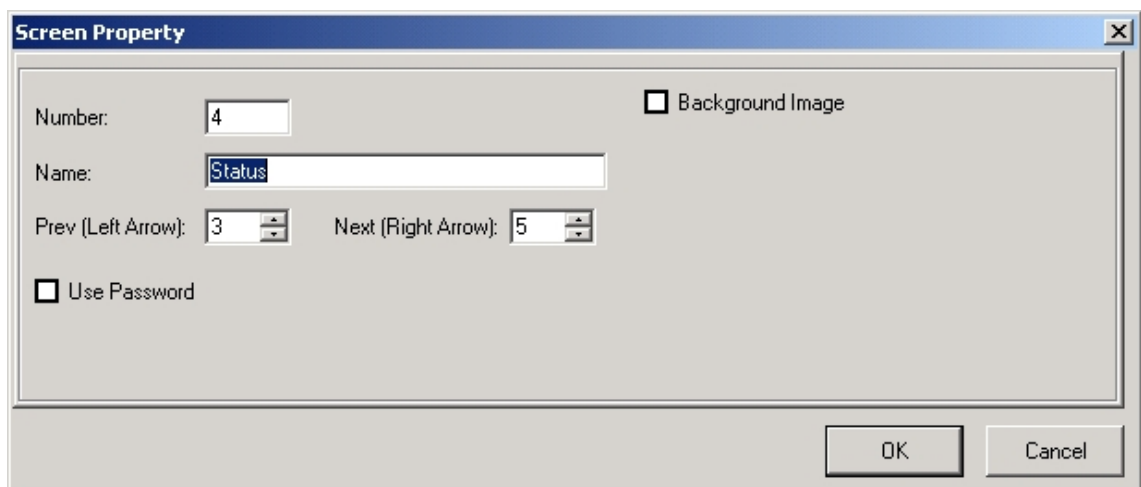

## Chapter 6. Panel Editor

### 6.1.3 Toolbar

1) Various tags and edit tools are displayed, and they also can be split and put together in new arrangements.

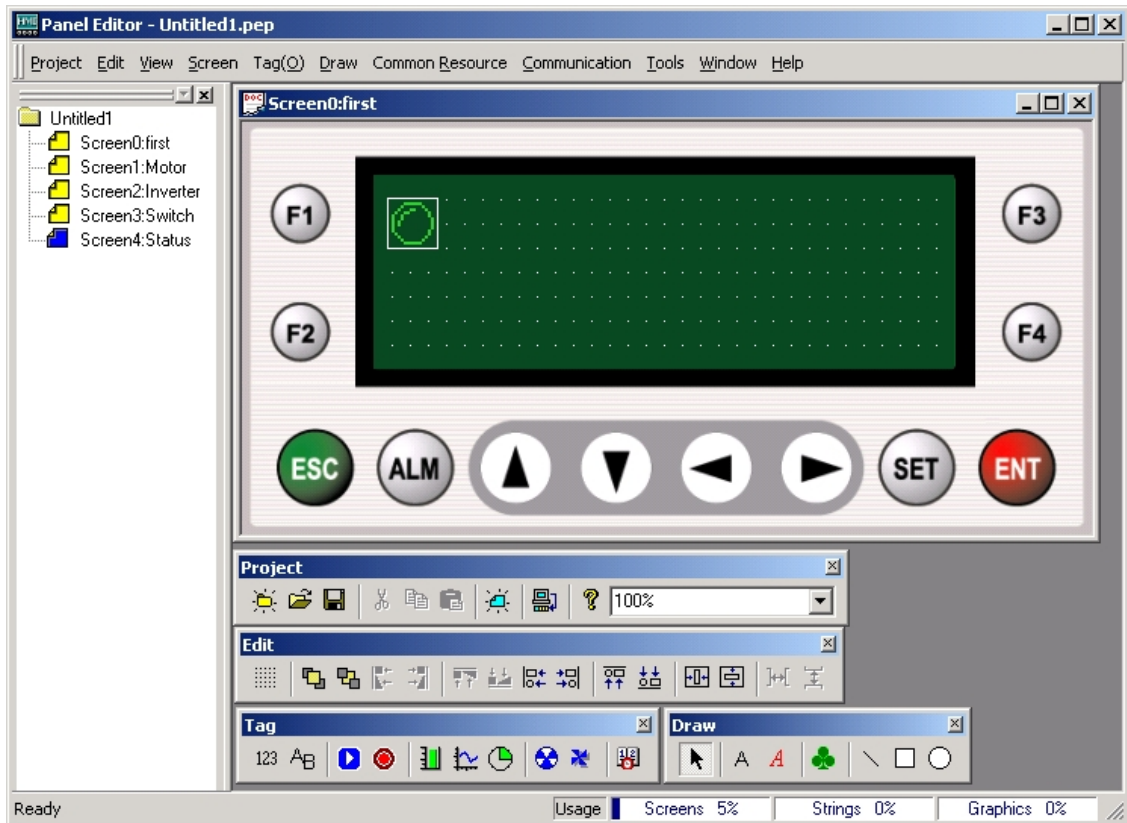

2) The following are the default toolbars.

Toolbars	Function	Remark
Tag	Displays toolbar for Tag functions such as, Numeric, Message and Button.	
Draw	Displays toolbar for Draw functions such as, Text, Image Text and Bitmap.	
Project	Displays toolbar for Project functions such as, Open, Save and Download.	
Edit	Displays toolbar for Edit functions such as, Order, Align and Space.	

### 6.1.4 Menu

1) Displays the various functions of the Panel Editor. It can be split and put together in new arrangements.

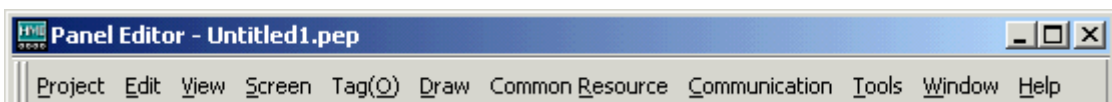

## 6.2 Project Window

This section describes the Project Window.

### 6.2.1 Project Window Tree

The Project Window is shown in below.

Project name	Shows the current project name.
--------------	---------------------------------

Screen name	Shows the specified name for each screen.
Screen number	Shows the assigned number for each screen.

### 6.2.2 Edit Project Window

#### 1) New Screen

This section describes how to make a new screen in the project window.

(1) Place the mouse pointer on the item and click the right mouse button, then the pop-up menus are displayed.

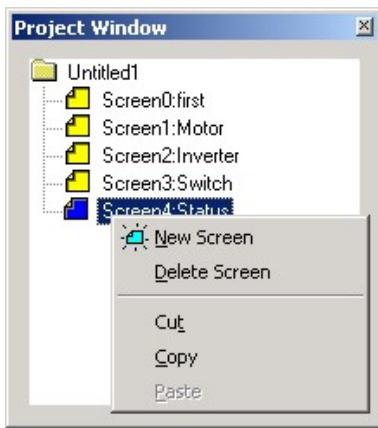

(2) Select 'New Screen' from the menu, and then the following 'Create New Screen' window is displayed.

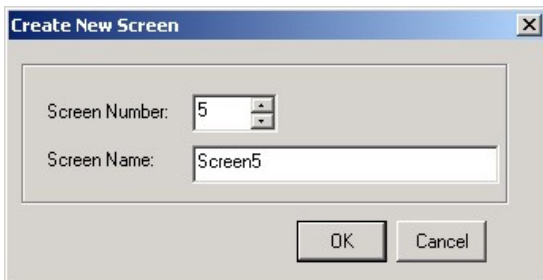

## Chapter 6. Panel Editor

- (3) Click OK after entering the Screen Number and the Screen Name, then the new screen and the project window are added to the Edit Window.

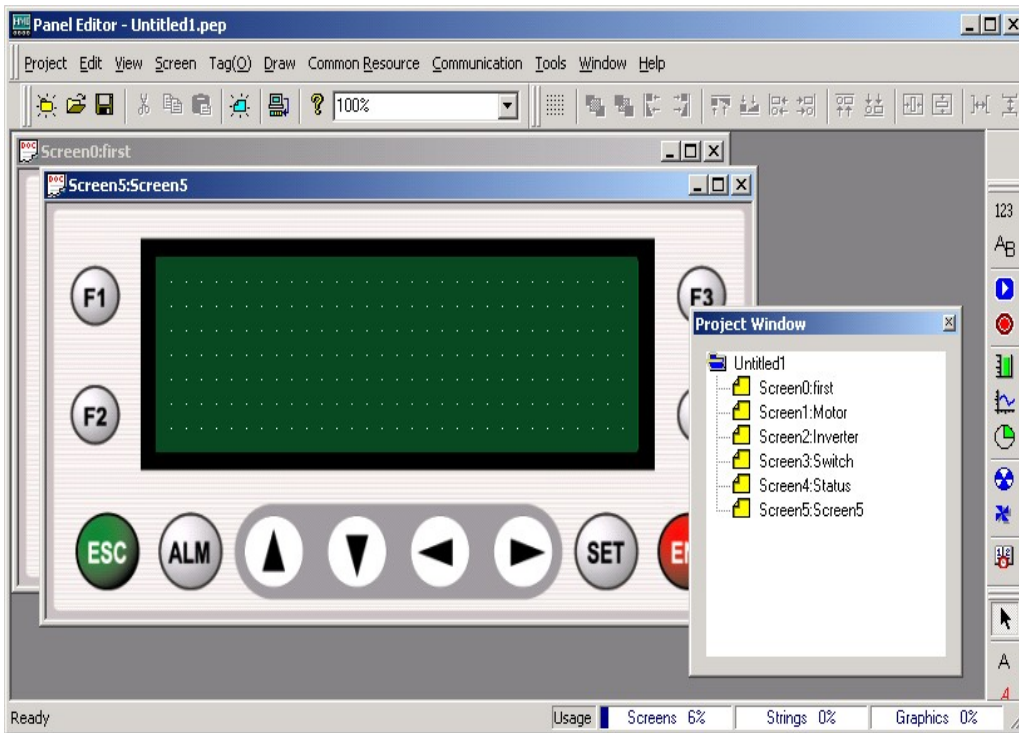

### 2) Delete Screen

This section describes how to delete the screen from the Project Window.

- (1) Place the mouse pointer on the item and click the right mouse button, then the pop-up menu shown in below are displayed.

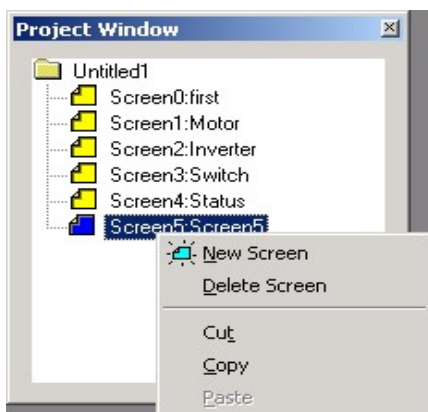

## Chapter 6. Panel Editor

---

- (2) The 'Delete Screen' item is selected, the screen is deleted from the project.

However, the last screen cannot be deleted if there is only one screen left because the project should have at least one screen.

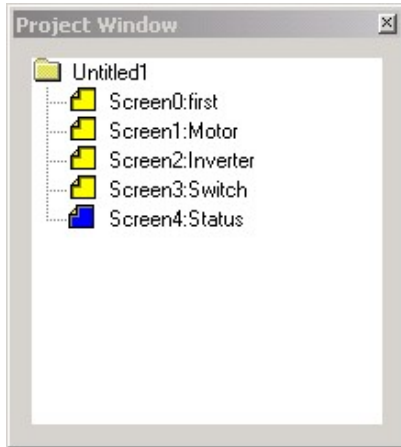

### 3) Cut, Copy, Paste

This section describes how to 'Cut', 'Copy', 'Paste' in the Project Window.

- (1) Place the mouse pointer on the item to cut and copy and click the right mouse button, then the pop-up menus shown in below are displayed.

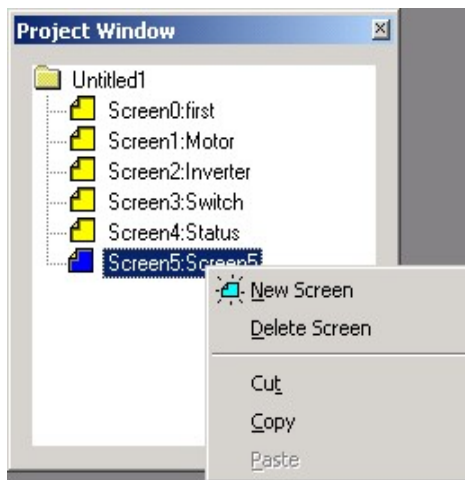

- (2) The selected screen is cut when the 'Cut' item is selected. If 'Copy' is selected, the selected screen is not cut but copied.

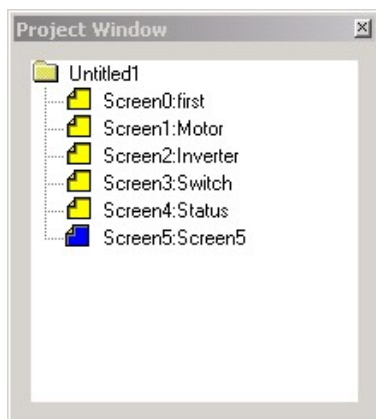

- (3) The cut or copied screen can be pasted to a new project.

### 6.3 Screen Edit Window

This section describes the Screen Edit Window.

#### 6.3.1 Screen Edit Window

##### 1) View Screen Edit Window

- (1) Select screen to edit, and then screen is displayed.
- (2) Multi-layer edit is available.

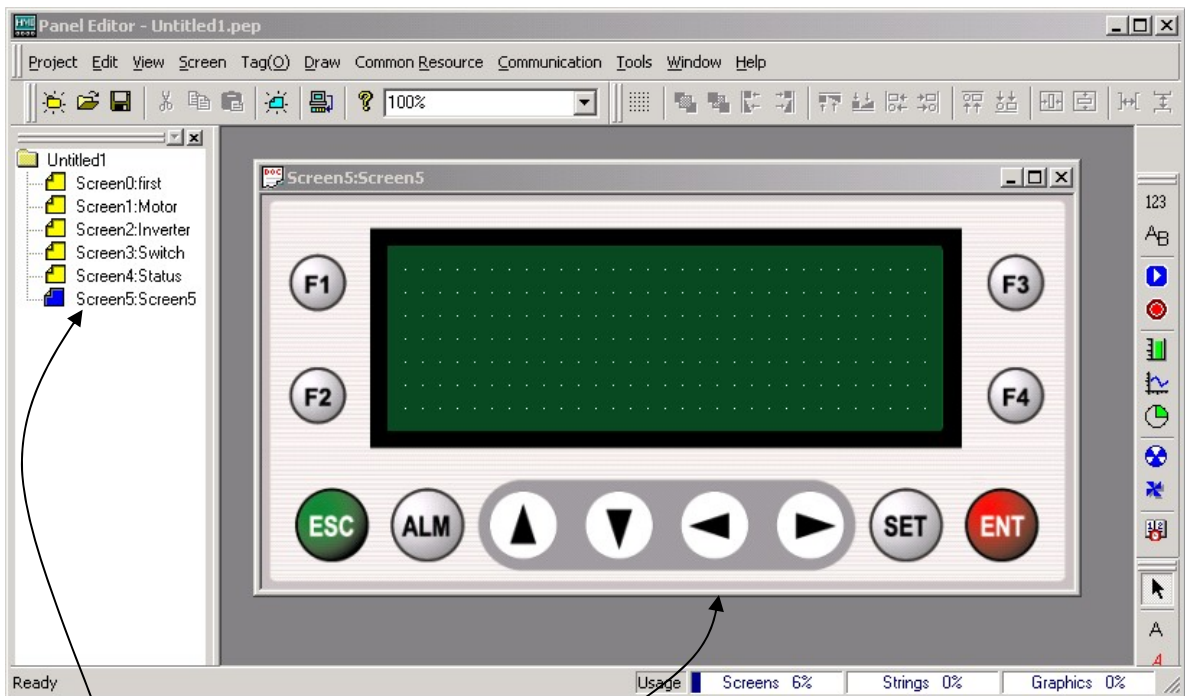

It is activated when the item is selected.

## Chapter 6. Panel Editor

---

### 2) Screen Edit Menu

(1) Click right button on the edit area (the green area of the edit window), then the following pop-up menus are displayed.

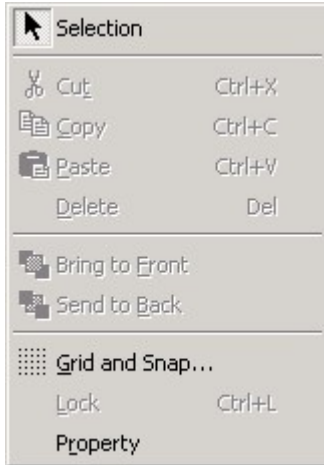

(2) Select 'Property', then the 'Screen Property' window is displayed.

(3) It can also be displayed when it is double-clicked.

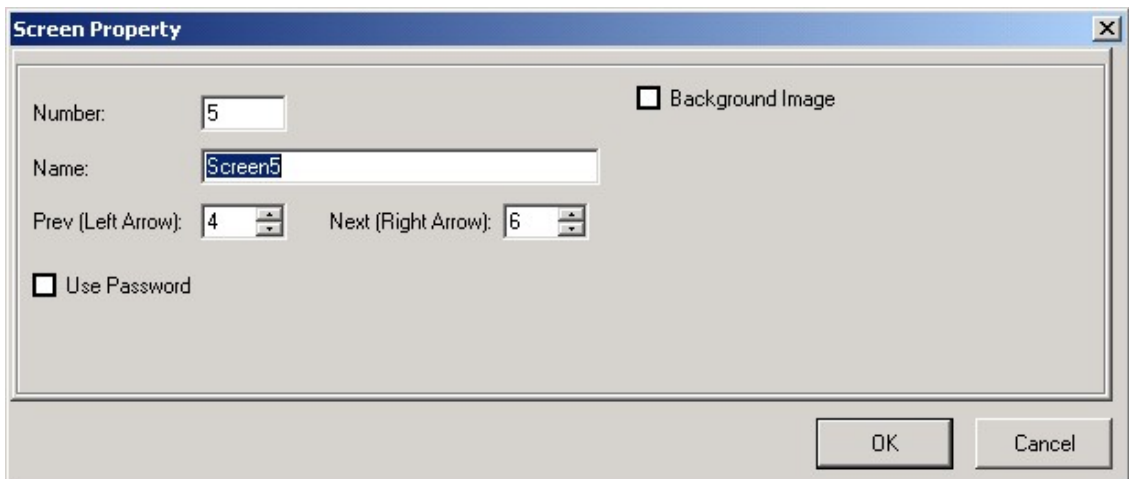

(4) Select 'OK' to save the screen properties.

### 3) Screen Property

The properties that can be set in the 'Screen Property' are as follow:

- (1) Number: Specifies the current screen number. The number already assigned cannot be used again.
- (2) Name: Specifies the current screen name.
- (3) Prev (Left Arrow): Specifies the previous screen number when the '◀' key is pressed.
- (4) Next (Right Arrow): Specifies the next screen number when the '▶' key is pressed.
- (5) Use Password: When it is selected, the XGT Panel does not show the corresponding screen.

To password should be released to see the locked window.

- (6) Background Image: Allows user to decide a background image.



## Chapter 6. Panel Editor

---

- ① When it is selected, user can select a background image as shown below.

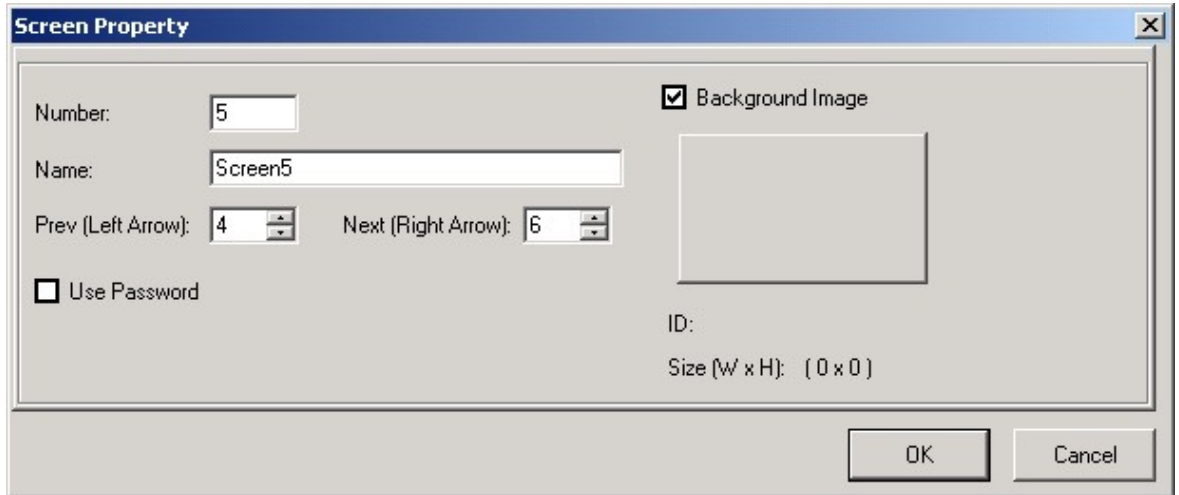

- ② When the Image Select Box is selected, Image Library is displayed as shown below.



- ③ Image Library is divided into four sections including User, Lamp/Button, Rotate and Move, and 'Add' and 'Delete' for each library are easy. However, only black-and-white bitmap images under 192\*64 are available. (If a colored image is imported, it is automatically changed to a black-and-white image.)

## Chapter 6. Panel Editor

- ④ Select the image to use and click 'OK'. When the background image is specified, the image's ID and size are displayed.

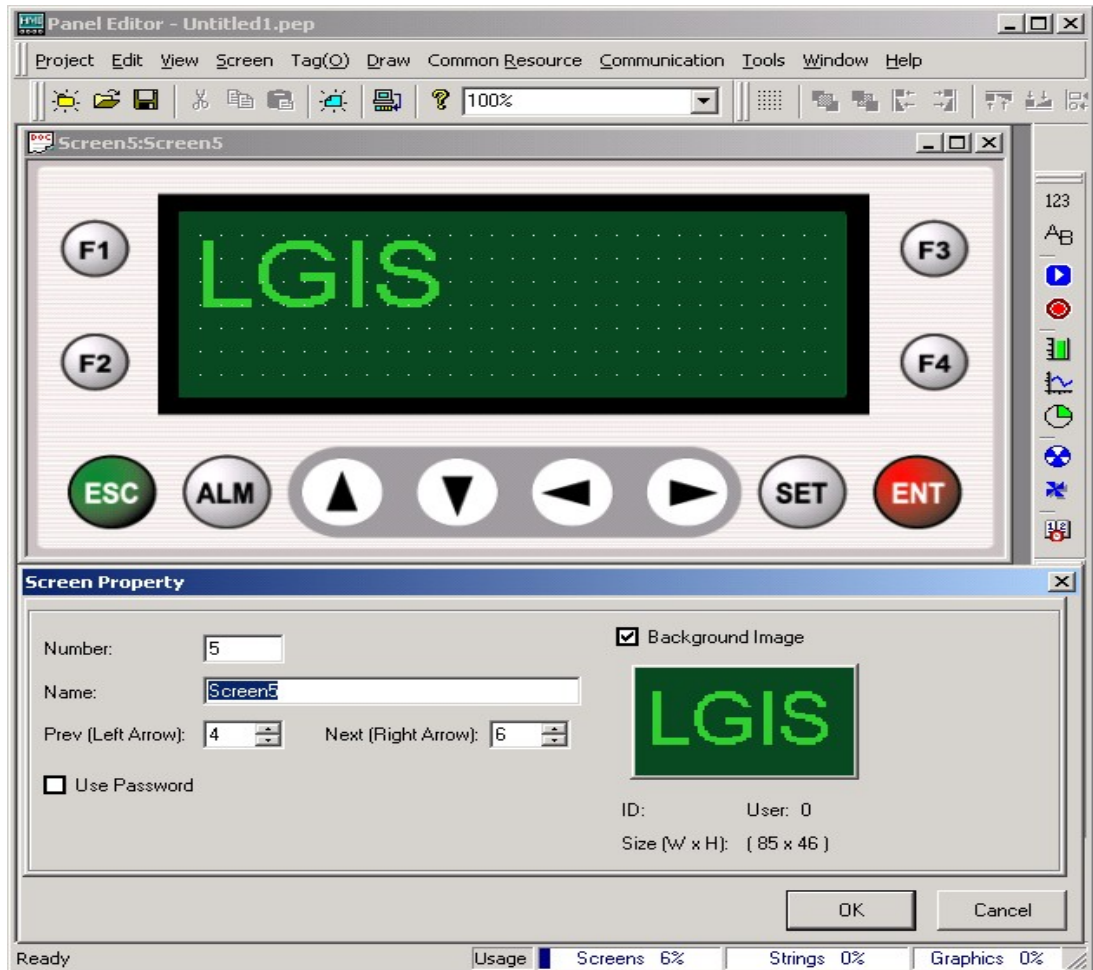

### 6.4 Menu & Toolbar

The following explains about the menus and the toolbar.

#### 6.4.1 Menus

Name and function of menus are as follow.

Menu	Sub-Menu	Function
Project	New Project	Creates a new project.
	Open Project	Opens an existing project.
	Close Project	Closes the current project.
	Save Project	Saves the active project.
	Save As	Saves the active project with a new name.
	Change PLC Type	Changes PLC type.
	Change COM Port	Changes COM Port.
	Print	Prints the active screen.
	Print Preview	Previews the screen to be printed.
	Exit	Quit Panel Editor.
Edit	Cut	Cuts the selection and put it on the Clipboard.
	Copy	Copies the selection and put it on the Clipboard.
	Paste	Insert Clipboard contents.
	Delete	Deletes the selected tag(s) or screen(s).
	Order	Allows user to arrange tags on different layers.
	Align/Space	Aligns multiple tags by the same reference point.
	Grid and Snap	Displays or hides grid, sets an interval of grid and makes the starting point of the tag come on a grids when 'snap to grid' is checked.
	Select All	Selects all tags on the screen.
	Lock Tag	Locks properties and position of selected tags.
	Unlock Tag	Unlocks every fixed tag on the current screen.
View	Status Bar	Shows or hides the status bar.
	Memory Usage	Shows memory usage of each screen.
	System Memory Usage	Shows used system memory area.
	Zoom Box	Magnifies the area where the cursor is.

## Chapter 6. Panel Editor

Menu	Sub-Menu	Function
Screen	New Screen	Creates a new screen.
	Delete Screen	Deletes a selected screen.
	Screen Property	Shows current screen property dialog.
	Tag List	Shows the tag list on the current screen.
	Function key List	Shows the function key list on the current screen.
Tag	Numeric	Adds Numeric tag.
	Message	Adds Message tag.
	Button	Adds Button tag.
	Lamp	Adds Lamp tag.
	Bar Graph	Adds Bar Graph tag.
	Trend Graph	Adds Trend Graph tag.
	Pie Graph	Adds Pie Graph tag.
	Rotate	Adds Rotate tag.
	Move	Adds Move tag.
	Clock	Adds Clock tag.
Draw	Selection	Changes to selection mode.
	Text	Adds Text tag.
	Image Text	Adds Image Text tag.
	Image	Adds Image tag.
	Line	Adds Line tag.
	Rect	Adds Rectangle tag.
	Circle	Adds Circle tag.
Common Resource	Message	Registers, updates, and deletes the message.
	Image	Shows used image information.
	Parameter	Sets XGT Panel parameter.
	Alarm	Sets alarm information.
	Calculation	Sets calculation information.
	Block Communication	Sets block communication information.
	Reservation	Sets reservation.

## Chapter 6. Panel Editor

Menu	Sub-Menu	Function
Communi- -cation	Download	Downloads data to XGT Panel.
	Upload	Uploads data from XGT Panel.
	Font	Downloads font file.
	Date/Time	Sets data and time of XGT Panel (B type only).
	Password	Sets password for upload/download.
	Clear Password	Clears password for up/download.
	Format	Formats entire memory area of XGT Panel.
	OS Download	Downloads OS file to XGT Panel.
	Upload alarm history	Uploads alarm history from XGT Panel.
	Erase alarm history	Deletes alarm history of XGT Panel.
Upload system information	Uploads version, menus, system information of XGT Panel.	
Tools	Customize Toolbars	Configures user defined toolbars.
	Customize Keyboard	Configures user defined shortcut keys.
	Option	Configures project auto-save interval, color, program resource language.
Window	Cascade	Arranges all the windows in the work area in a cascading fashion, one behind another.
	Tile	Arranges windows as non-overlapping tiles.
	Arrange Icons	Arranges icons at the bottom of the window.
	Close All	Closes all the windows.
Help	Help Contents	Lists Help topics.
	About Panel Editor	Displays program information, version number and copyright of Panel Editor.







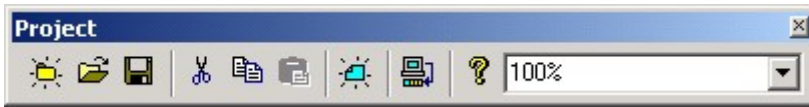

## Chapter 6. Panel Editor

### 6.4.2 Toolbar

Icons and functions of toolbar are as follow.



#### 1) Project Toolbar

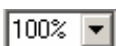



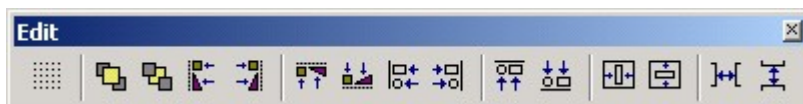









Tool	Menu	Description
	New	Creates a new project.
	Open	Opens an existing project.
	Save	Saves the active project.
	Cut	Cuts the selection and put it on the Clipboard.
	Copy	Copies the selection and put it on the Clipboard.
	Paste	Inserts Clipboard contents.
	New screen	Creates a new screen.
	Download	Downloads data to XGT Panel.
	About	Displays Panel Editor Help.
	Zoom	Specifies the window size.

#### 2) Edit Toolbar







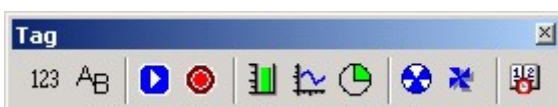

Tool	Menu	Description
	Grid and snap	Sets grid spacing and snap method.
	Bring to front	Sends a selected tag to the front.
	Send to back	Sends a selected tag to the back.

## Chapter 6. Panel Editor





Tool	Menu	Description
	Align to Left	Aligns selected tags based on their left edge.
	Align to Right	Aligns selected tags based on their right edge.
	Align to top	Aligns selected tags based on their top edge.
	Align to bottom	Aligns selected tags based on their bottom edge.
	Align to screen left	Aligns selected tags based on the screen's left edge.
	Align to screen right	Aligns selected tags based on the screen's right edge.
	Align to screen top	Aligns selected tags based on the screen's top edge.
	Align to screen bottom	Aligns selected tags based on the screen's bottom edge.
	Center in screen horizontally	Aligns selected tags based on their horizontal center.
	Center in screen vertically	Aligns selected tags based on their vertical center.
	Space evenly across	Aligns selected tags evenly based on the horizontal line.
	Space evenly down	Aligns selected tags evenly based on the vertical line.

### 3) Tag Toolbar









Tool	Menu	Description
	Numeric	Add Numeric tag.
	Message	Add Message tag.
	Button	Adds Button tag.
	Lamp	Adds Lamp tag.
	Bar Graph	Adds Bar Graph tag.
	Trend Graph	Adds Trend Graph tag.

## Chapter 6. Panel Editor

Tool	Menu	Description
	Pie Graph	Adds Pie Graph tag.
	Rotate	Adds Rotate tag.
	Move	Adds Move tag.
	Clock	Adds Clock tag.

### 4) Draw Toolbar



Tool	Menu	Description
	Selection	Changes to Selection Mode.
	Text	Adds Text tag.
	Image Text	Adds Image Text tag.
	Image	Adds Image tag.
	Line	Adds Line tag.
	Rect	Adds Rectangle tag.
	Circle	Adds Circle tag.

#### REMARK

- 1) Each toolbar can be positioned to float anywhere convenient.
- 2) User can customize toolbars on the tools menu. For details, refer to the section 6.13.1 'Customize Toolbars'.



## 6.5 Project Menu

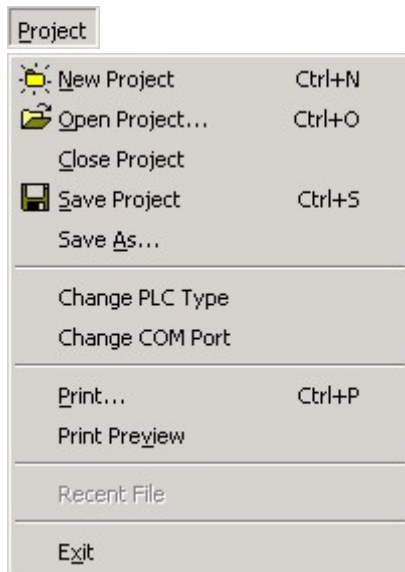

### 6.5.1 New Project

Select 'New Project' to create a new project, then a Create New Project window will appear.

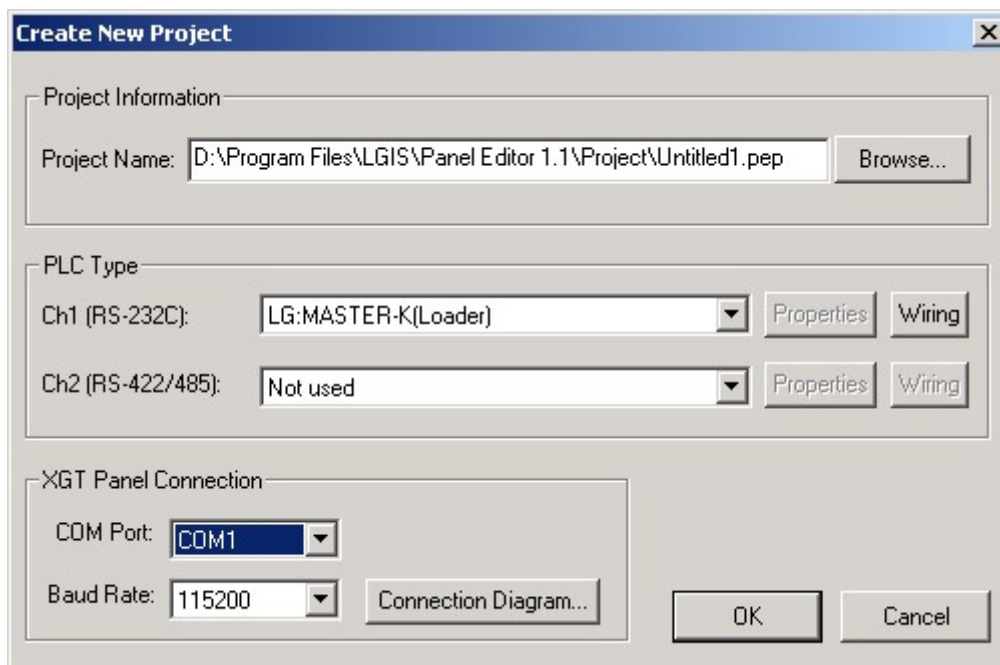

## Chapter 6. Panel Editor

### 1) Project Information

(1) File name: Designates path and name of project

(2) Open Project: Select 'Open', then the figure below is displayed. Set the directory for the new project and enter the file name.

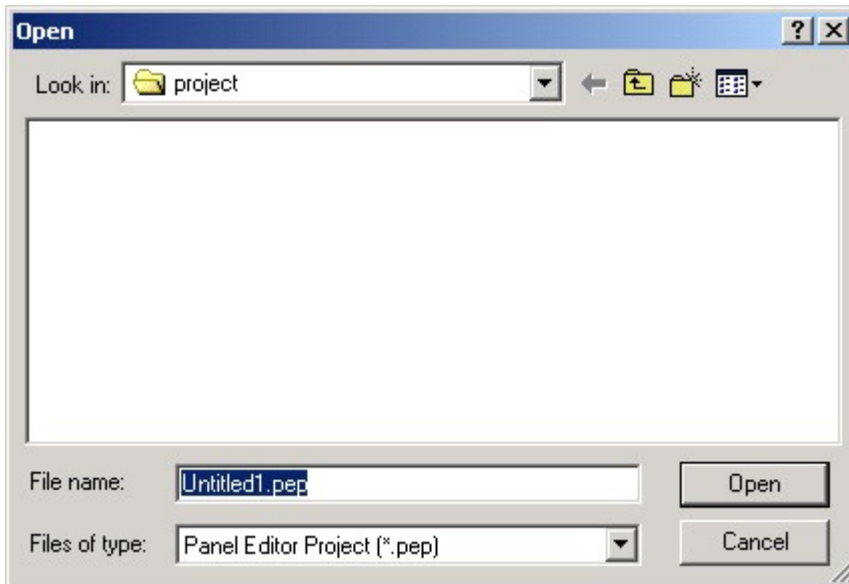

### 2) XGT Panel Connection

Selects the communication port and the baud rate for the Panel Editor and the XGT Panel's communication.

(1) COM Port:: From COM1 to COM8 can be selected. Set the correct port of the PC for the serial communication.

(2) Baud Rate: One of 9,600bps, 38,400bps, and 115,200 bps can be selected, and 115,200bps is set as default.

The same download speed for the XGT Panel should be the same.

The XGT Panel download speed setting method is described in the section 7.1.4.

### 3) Connection Diagram

Displays the connection diagram between the Panel Editor and the XGT Panel.

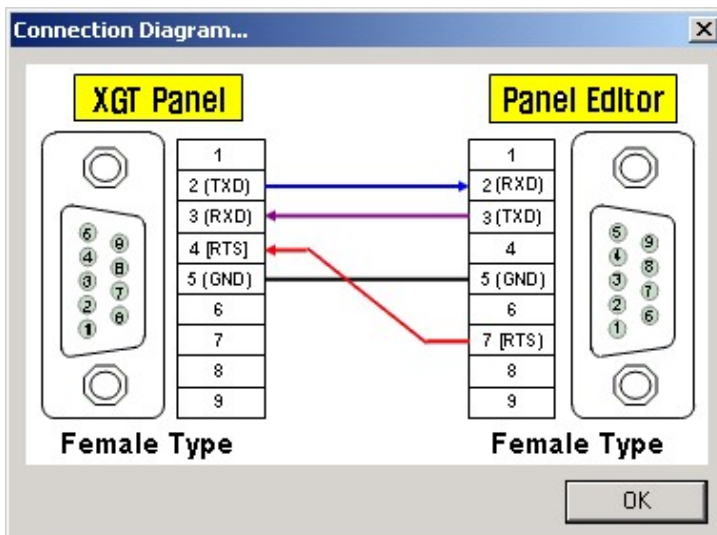

## Chapter 6. Panel Editor

### 4) PLC type

Designate the type of PLC to connect for each channel (Ch.1: RS-232C, Ch.2: RS-422/485).

	Available Devices	Description
Ch 1 RS-232C	Not used	Not used
	LS:MASTER-K(Loader)	Select to connect to LS MASTER-K series loader port.
	LS:GLOFA-GM(Loader)	Select to connect to LS GLOFA series loader port.
	LS:MASTER-K(Link)	Select to connect to LS MASTER-K series Cnet port.
	LS:MASTER-K(Link) 500H 1000H	Select to connect to LS MASTER-K 500H, 1000H series.
	LS:MASTER-K(Link) 10S 30S 60S 100S	Select to connect to LS MASTER-K 10/30/60/100S series.
	LS:MASTER-K(Link) 10S1	Select to connect to LS MASTER-K 10S1.
	LS:GLOFA-GM(Link)	Select to connect to LS GLOFA series Cnet port.
	LS:Slave(Link)	Set the XGT Panel as a slave of LS Cnet.
	LS:Inverter	Select to connect to the LS inverter.
	MODBUS_Master(RTU)	Set the XGT Panel as a MODBUS RTU mode master.
	MODBUS_Master(ASC)	Set the XGT Panel as a MODBUS ASC mode master.
	MODBUS_Slave(RTU)	Set the XGT Panel as a MODBUS RTU mode slave.
	MODBUS_Slave(ASC)	Set the XGT Panel as a MODBUS ASC mode slave.
	MELSEC FX(LINK)	Select to connect to the MITSUBISHI FX series.
	OMRON:C-Mode	Select to connect to the OMRON PLC through C-Mode.
	KOYO_DL06	Select to connect to the KOYO Direct 06.
	NAIS:FP_MEWTOCOL	Select to connect to the NAIS FP series through MEWTOCOL.
ST/PS-9000	Select to connect to the ST/PS-9000.	
Ch 2 RS-422 /485	Not used	Not used
	LS:MASTER-K(Link)	Select to connect to LS MASTER-K series Cnet port.
	LS:MASTER-K(Link) 500H 1000H	Select to connect to LS MASTER-K 500H, 1000H series.
	LS:MASTER-K(Link) 10S 30S 60S 100S	Select to connect to LS MASTER-K 10/30/60/100S series.
	LS:MASTER-K(Link) 10S1	Select to connect to LS MASTER-K 10S1.
	LS:GLOFA-GM(Link)	Select to connect to LS GLOFA series Cnet port.

## Chapter 6. Panel Editor

	Available devices	Description
Ch 2 RS-422 /485	LS:Slave(Link)	Set the XGT Panel as a slave of LS Cnet.
	LS:Inverter	Select to connect to the LS inverter.
	MODBUS_Master(RTU)	Set the XGT Panel as a MODBUS RTU mode master.
	MODBUS_Master(ASC)	Set the XGT Panel as a MODBUS ASC mode master.
	MODBUS_Slave(RTU)	Set the XGT Panel as a MODBUS RTU mode slave.
	MODBUS_Slave(ASC)	Set the XGT Panel as a MODBUS ASC mode slave.
	MELSEC FX(LINK)	Select to connect to the MITSUBISHI FX series.
	OMRON:C-Mode	Select to connect to the OMRON PLC through C-Mode.
	KOYO_DL06	Select to connect to the KOYO Direct 06.
	NAIS:FP_MEWTOCOL	Select to connect to the NAIS FP series through MEWTOCOL.
	ST/PS-9000	Select to connect to the ST/PS-9000.
	Fuji_inv_FVR_E11S	Select to connect to the Fuji inverter E11S..
	Siemens:S7-200 PPI	Select to connect to the Siemens S7-200 through the PPI protocol.

### REMARK

- 1) The available devices will be added continually, so please check before purchasing.

### 5) Ch 1 Communication Properties

Click 'Properties', then the 'Communication Properties' window will be displayed as shown below.

A communication parameter must be equal to the PLC to connect to.

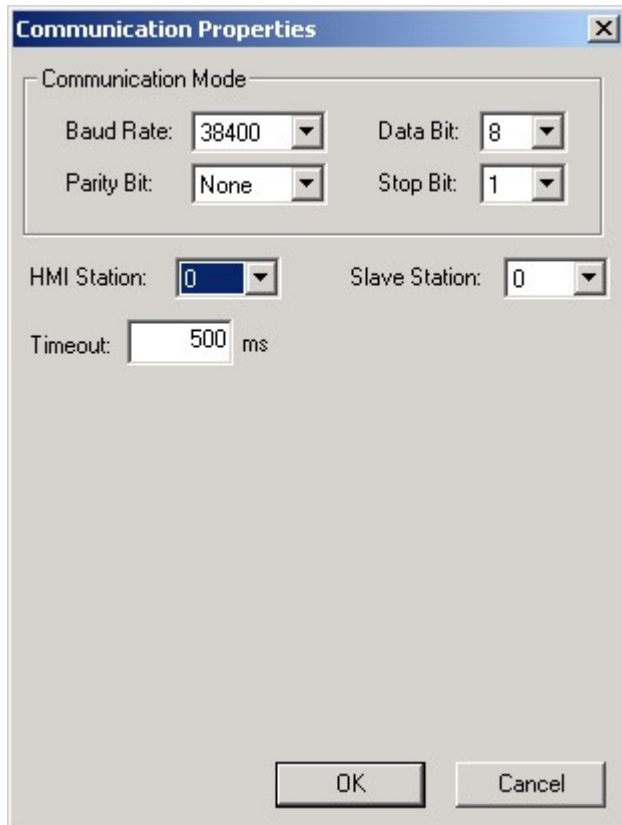

- ① Baud Rate: Choose one of 1200, 2400, 4800, 9600, 19200, 38400, 57600, 115200 BPS.
- ② Data Bit: Choose 7bits or 8bits.
- ③ Parity Bit: Choose one of None, Odd, Even.
- ④ Stop Bit: Choose 1 bit or 2 bits.
- ⑤ HMI Station: Choose the station No. of XGT Panel. (0-31)
- ⑥ Slave Station: Choose the station No. of slave station to connect. (0-31)  
Set the different station for the XGT Panel and the slave.
- ⑦ Timeout: Set communication timeout

### 6) Ch 2 Communication Properties

Click 'Properties', then the 'Communication Properties' window will be displayed as shown below.

A communication parameter must be equal to the PLC to connect to.

#### (1) 1:1 Configuration

Specifies the communication setting when the configuration should be set 1:1.

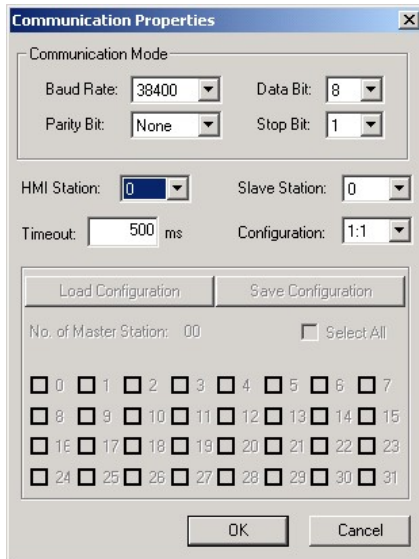

(A) Communication Mode, HMI Station and Timeout should be set identical to the communication channel 1.

#### (2) 1:N Configuration

Specifies the communication setting when the configuration should be set 1:N where one XGT Panel is set to be a master so to monitor several slaves.

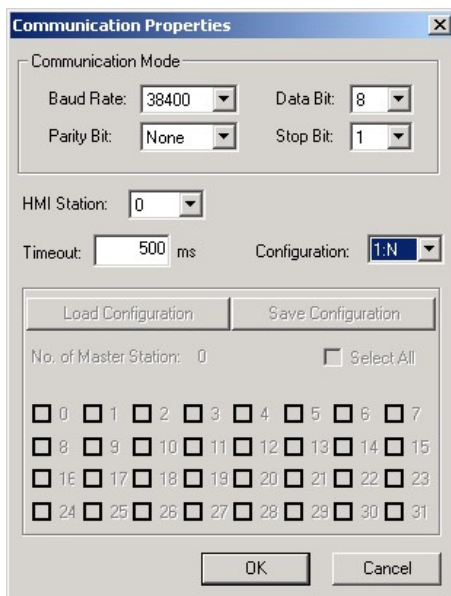

(A) Communication Mode, HMI Station and Timeout should be set identical to the 1:1 configuration.

## Chapter 6. Panel Editor

### (3) N:1 Configuration

Specifies the communication setting when the configuration should be set N:1 where several XGT Panels are set to be a multi-master so to monitor one slave.

(A) Communication Mode, HMI Station and Timeout should be set identical to the 1:1 configuration.

(B) For example, if each Station No. of 3 masters is 0, 1 and 2 respectively, and the Station No. of one slave is 3, setting for each master will be as follows.

(C) Communication Mode, HMI Station and Timeout should be set identical to the 1:1 configuration.

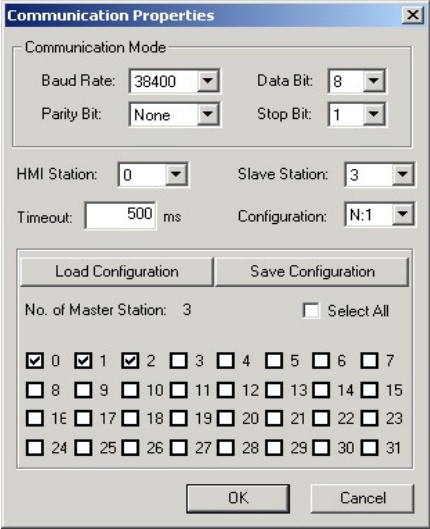
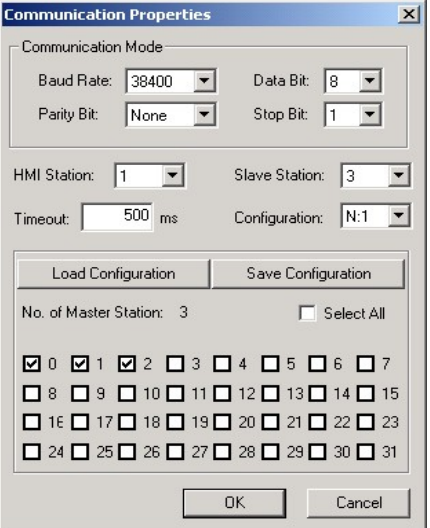
Station	Setting Screen	Setting Contents	
Station 0		HMI Station	To be set 0
		Slave Station	To be set 3
		Configuration	To be set N:1
		Master Station	Let all the master station numbers checked which configure the communication system. (0,1,2)
Station 1		HMI Station	To be set 1
		Slave Station	To be set 3
		Configuration	To be set N:1
		Master Station	Let all the master station numbers checked which configure the communication system. (0,1,2)

## Chapter 6. Panel Editor

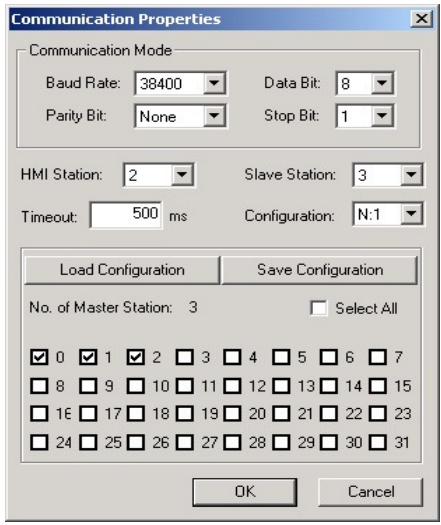
Station	Setting Screen	Setting Contents	
Station 2		HMI Station	To be set 2
		Slave Station	To be set 3
		Configuration	To be set N:1
		Master Station	Let all the master station numbers checked which configure the communication system. (0,1,2)

\* In case of N:1 and N:M communication, make sure all the master station numbers are set identical as shown above.

### (4) N:M Configuration

Specifies the communication setting when the configuration should be set N:M where several XGT Panels are set to be a multi-master so to monitor several slaves.

(A) Communication Mode, HMI Station and Timeout should be set identical to the 1:1 configuration.

(B) Master setting should be identical to the N:1 configuration.

### (5) Save Configuration

Convenient to use for N:1 and N:M communication, it saves the Master Station No. selected for other projects to open as necessary.

(A) Click Save Configuration button to show the window as below.

(B) Specify the Save File Name, and then click Save button to save the present master configuration.

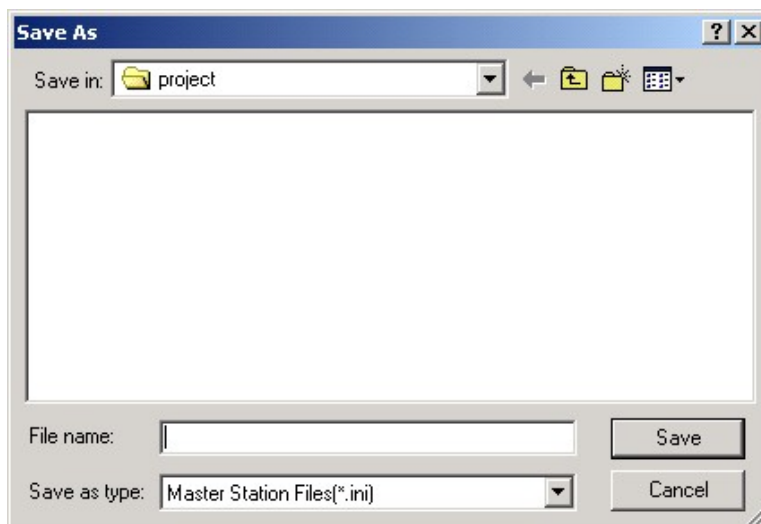



## Chapter 6. Panel Editor

### (6) Load Configuration

- (A) Click Load Configuration button to show the window as below.
- (B) Select the master configuration file to open, and then click Open button to set the master configuration of the present project as saved in the file.

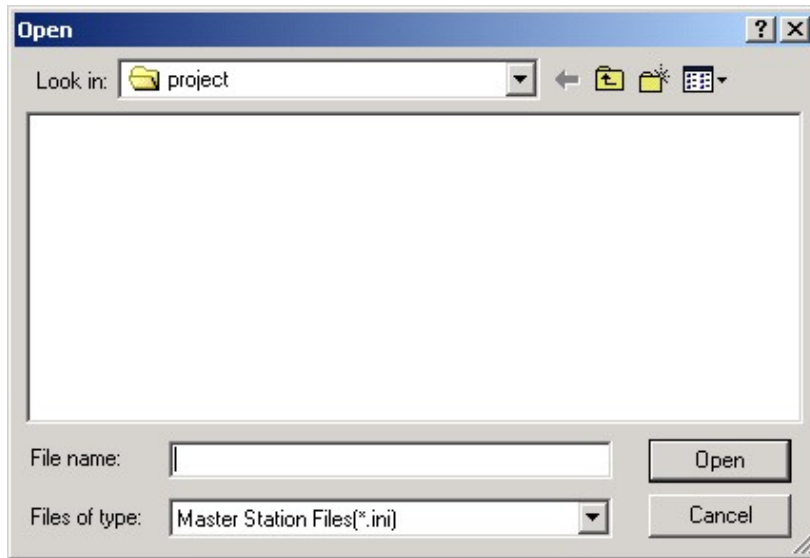

### (7) Wiring

Displays the connection diagram between the XGT Panel and PLC for each channel.

For instance, the following diagram is displayed if 'LS:MASTER-K(Loader)' is selected at the Ch. 1.

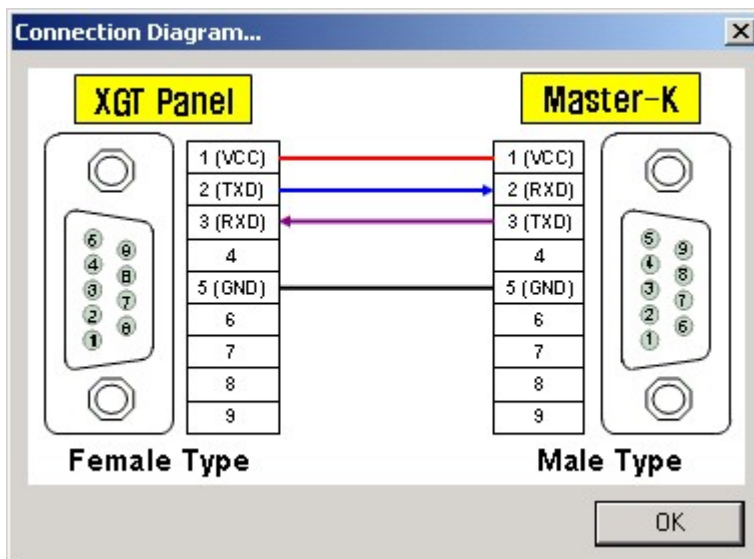

### 6.5.2 Open Project

Opens an exist project.

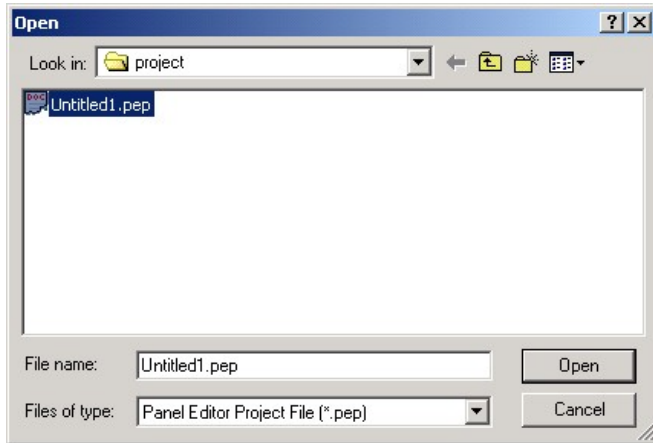

Select the project to open and click 'Open' button.

### 6.5.3 Save Project

Saves the current project.

### 6.5.4 Save As

Saves current project with a new name.

- (1) The below window is displayed when 'Save As' is selected.
- (2) Enter the name to save, and click 'Save' to save the current project.

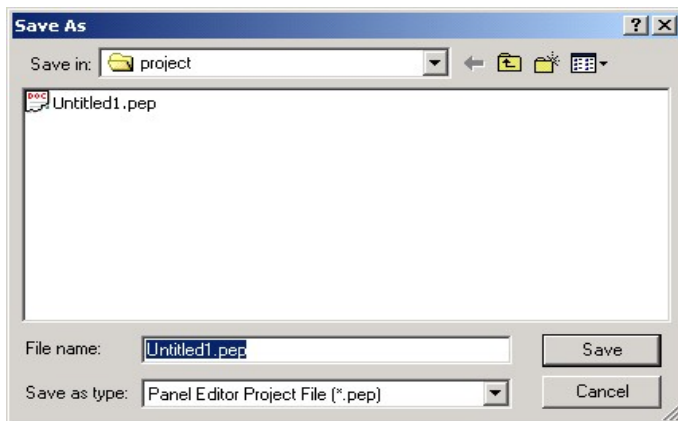

### 6.5.5 Change PLC Type

Changes current PLC type to connect to each channel.

- (1) Select 'Change PLC Type', and then the below window is displayed.

## Chapter 6. Panel Editor

- (2) Select the device to connect and specify the communication settings, and then the device is changed.
- (3) Refer to the section 6.5.1 for the communication setting and the wiring.

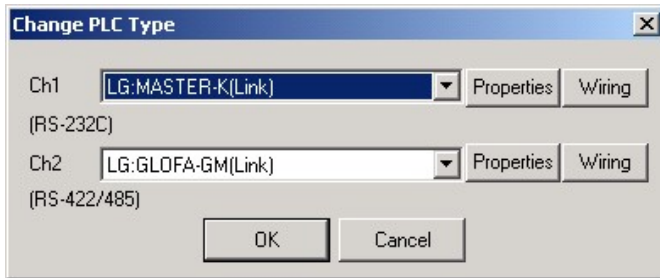

### 6.5.6 Change COM Port

Changes current COM Port and the baud rate.

- (1) Select 'Change COM Port', and then the below window is displayed.
- (2) Change the COM Port and Baud Rate, and select OK.
- (3) Refer to the section 6.5.1 for details.

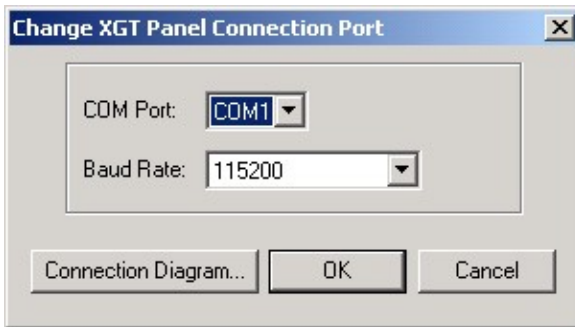

### 6.5.7 Print

Print the current screen, used tag list for each screen and properties.

- (1) Click 'Print' on the Project menu, then the figure shown below is displayed.

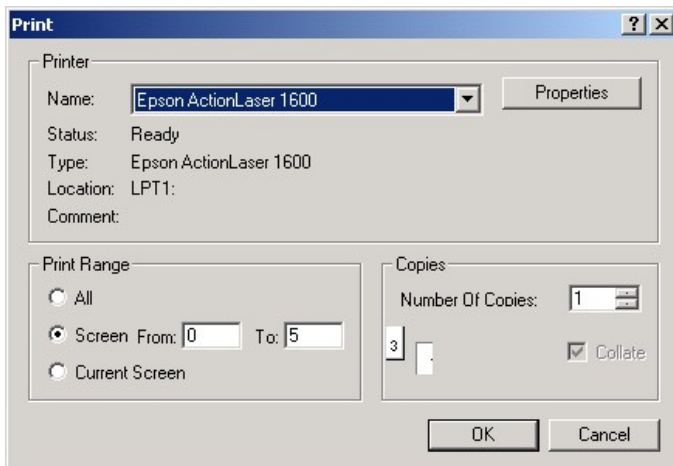

- (2) Set a printer, printer range and the number of copies.

## 6.5.8 Print Preview

Preview a page before printing.

- (1) On the Project menu, click 'Print Preview', then the figure as shown below is displayed.

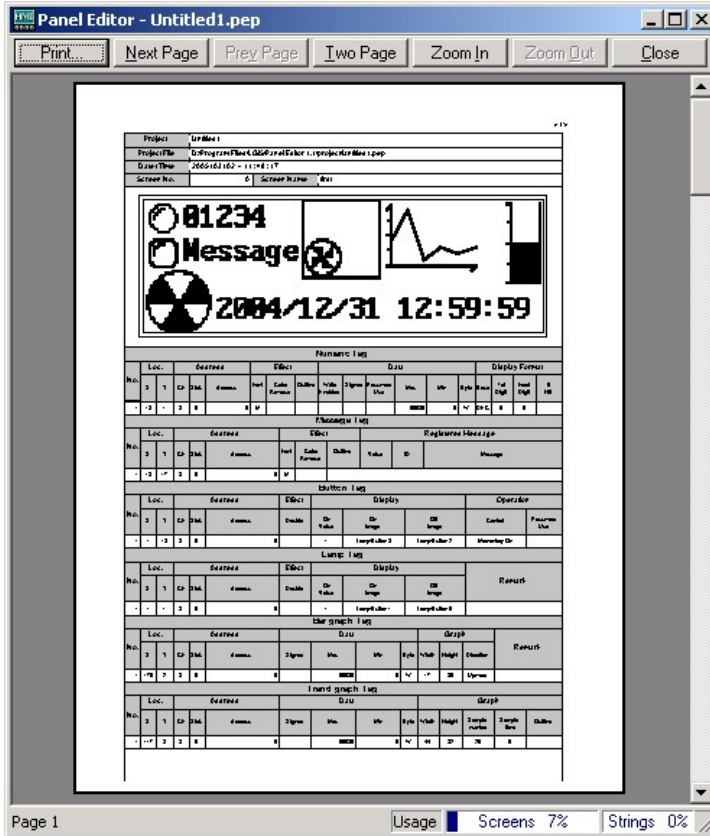

## 6.5.9 Recent File

Displays the recent projects. Up to 4 projects can be displayed and it is convenient to open projects.

## 6.5.10 Exit

Closes the Panel Editor.

- (1) Click 'Exit', then the figure shown below is displayed.

To save the changes, click 'Yes', to close without saving, click 'No', to cancel, click 'Cancel'.

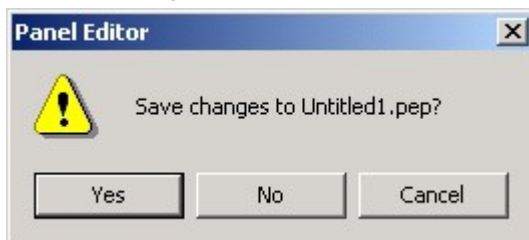

## 6.6 Edit Menu

Specifies Edit options.

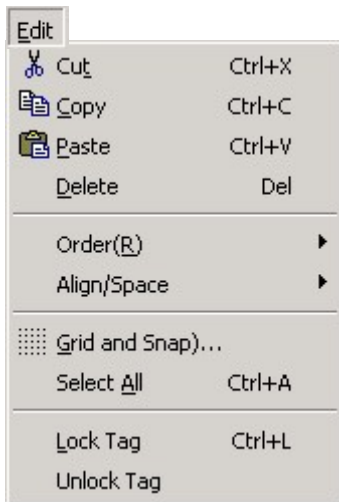

### 6.6.1 Cut

Cuts the selection and put it on the Clipboard.

### 6.6.2 Copy

Copies the selection and put it on the Clipboard.

### 6.6.3 Paste

Insert Clipboard contents.

### 6.6.4 Delete

Deletes the selected tag(s) or screen(s).

### 6.6.5 Order

Allows user to arrange tags on different layers.



#### 1) Bring to Front

Bring the selected tag to front when tags are overlapped.

#### 2) Send to Back

Send the tag to back.

### 6.6.6 Align / Space

Aligns and spaces multiple tags.

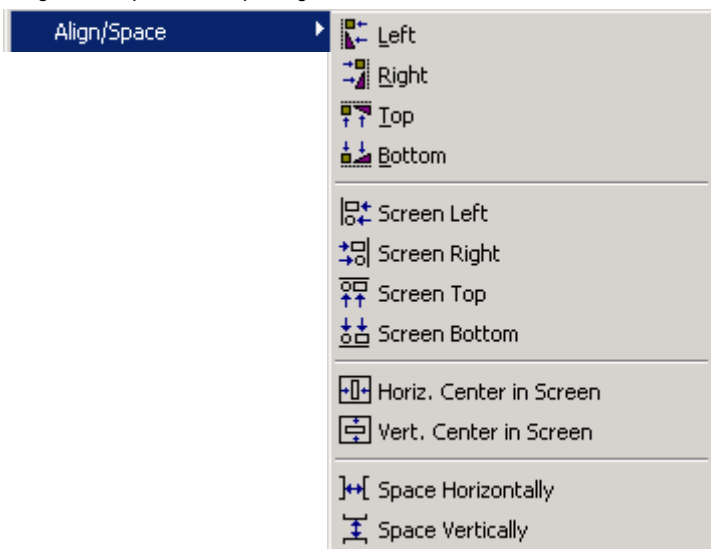

Icon	Item	Description
	Left	Align selected tags based on their left edge.
	Right	Align selected tags based on their right edge.
	Top	Align selected tags based on their top edge.
	Bottom	Align selected tags based on their bottom edge.
	Screen Left	Align selected tags based on left side of the screen.
	Screen Right	Align selected tags based on right side of the screen.
	Screen Top	Align selected tags based on topside of the screen.
	Screen Bottom	Align selected tags based on bottom side of the screen.
	Horiz. Center in Screen	Align selected tags based on horizontal center of the screen.
	Vert. Center in Screen	Align selected tags based on vertical center of the screen.
	Space Horizontally	Evenly space the selected tags horizontally. (If the sum of width of selected tags is larger than the distance to the end point from the starting point, Doesn't operates.)
	Space Vertically	Evenly space the selected tags vertically. (If the sum of width of selected tags is larger than the distance to the end point from the starting point, Doesn't operates.)

1) How to Align/Space

- (1) Select tags to align and space using the mouse.
- (2) In Align/Space of the Edit menu, select desired Align/Space option.
- (3) Selected tags will be aligned.

2) Results of Align/Space

In the following example, some tags selected are shown as aligned and spaced.

Align/Space	Before	After
Left		
Right		
Top		
Bottom		
Screen Left		

Align/Space	Before	After
Screen Right		
Screen Top		
Screen Bottom		
Horiz. Center in Screen		
Vert. Center in Screen		
Space Horizontally		
Space Vertically		



### 6.6.7 Grid and Snap

Grid set, Pitch, Style on the screen and whether to snap to grid.

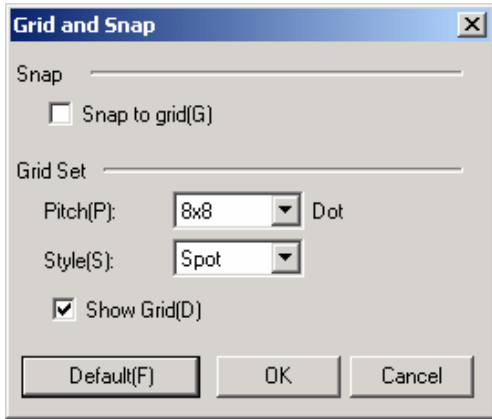

#### 1) Snap

If a tag is set to move aligned on the grid, the tag will move, being aligned on the spaced grid.

Makes the starting point of the tag comes on grids.

#### 2) Grid Set

(1) Pitch: Specifies the snap spacing. (One of 4x4, 6x8, 8x8, 12x16, 16x16, 24x16 and 32x16)

(2) Style: Specifies style of grid line. (One of Spot, Dotted Line, and Solid Line)

(3) Show Grids: Specifies whether to display grid or to hide.

(4) Default: Makes the Grid-dotting up as default values. (8x8 size, spot, show grid)

#### 3) Example of Grid Set

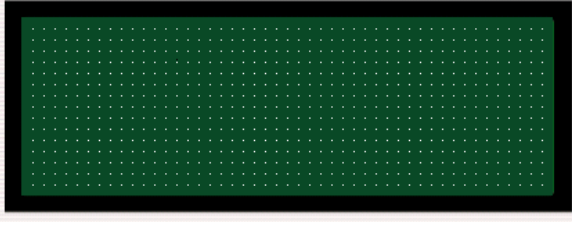
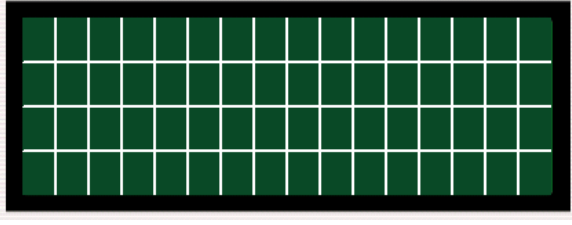
Panel Editor Screen	Setting Value	Setting Value
	Pitch: 4 x 4	Pitch: 4 x 4
	Style: Spot	Style: Spot
	Pitch: 12 x 16	Pitch: 12 x 16
	Style: Solid Line	Style: Solid Line

### 6.6.8 Select All

Selects all tags on the screen.

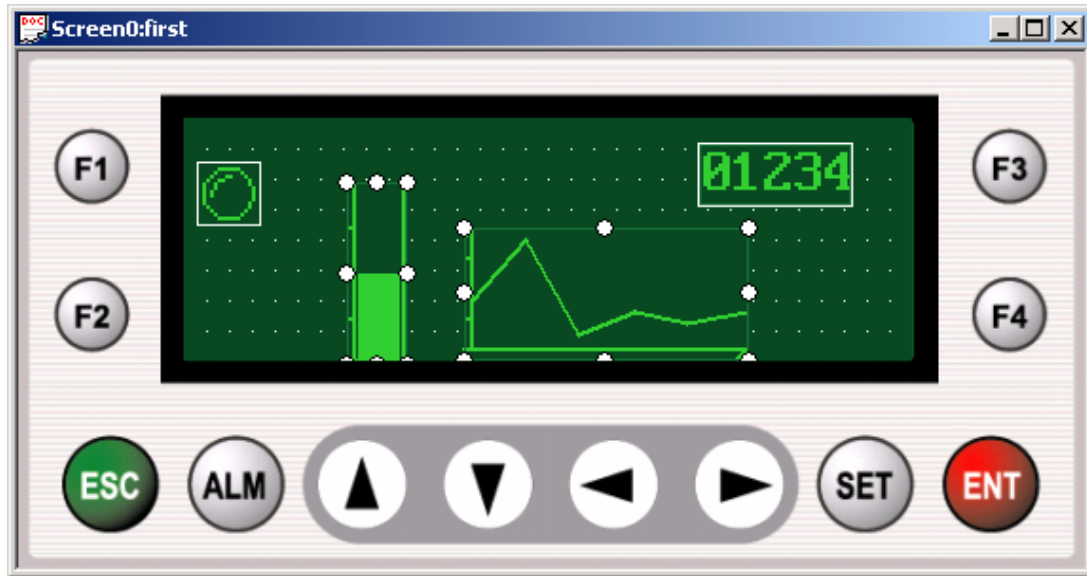

### 6.6.9 Lock Tag

Locks properties and position of selected tags.

Tag's properties and position are locked until "Unlock Tag" is selected.

### 6.6.10 Unlock Tag

Unlocks every locked tags on the current screen.

The Edit menus are also available when the right button of the mouse is clicked on the edit window.

### 6.6.11 Pop-up Menu

Click the right mouse button on screen window. Then, the Pop-Up menu appears and you can use some of the Edit functions

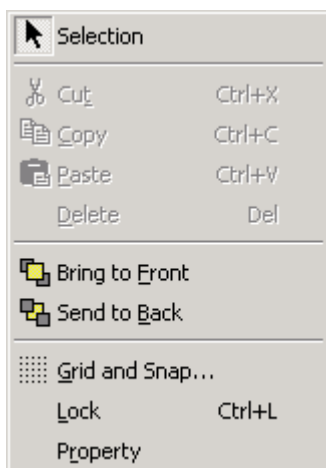

### 6.7 View Menu

Specifies View options.

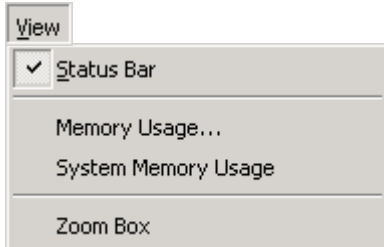

#### 6.7.1 Status Bar

In the bottom of the Panel Editor, the Status Bar will be activated if checked.

The Status Bar is being activated as shown in the figure below.



#### 6.7.2 Memory Usage

Displays the current usage of the memory.

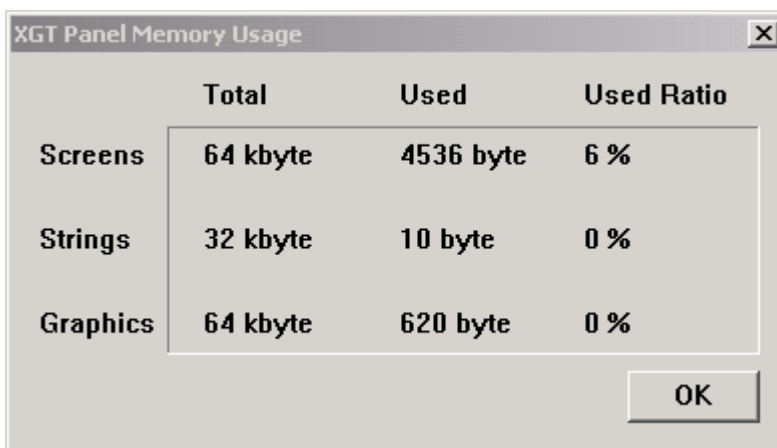

	Total	Used	Used Ratio
Screens	64 kbyte	4536 byte	6 %
Strings	32 kbyte	10 byte	0 %
Graphics	64 kbyte	620 byte	0 %

OK

Displays the usage quantity and usage ratio of the memory for screens, strings and graphics.

Relevant data can be identified in the Status Bar even during screens editing.

### 6.7.3 System Memory Usage

Shows the usage status and purposes (Read, Write, Read and Write) of the S area of the XGT Panel.

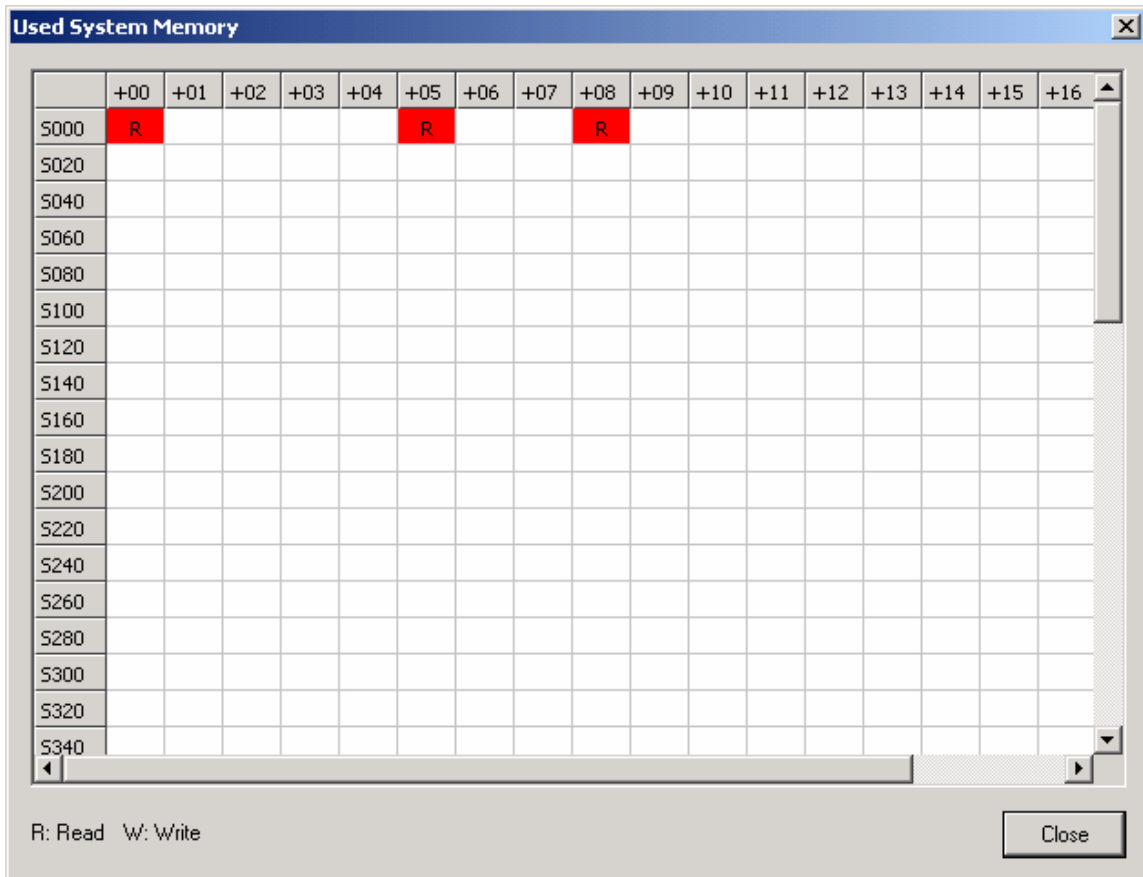

The image shows a window titled "Used System Memory" with a grid of memory addresses and their usage status. The grid has 17 columns labeled +00 through +16 and 17 rows labeled S000 through S340. The cells for S000+00, S000+05, and S000+08 are highlighted in red and contain the letter 'R'. A legend at the bottom left indicates "R: Read W: Write". A "Close" button is located at the bottom right.

	+00	+01	+02	+03	+04	+05	+06	+07	+08	+09	+10	+11	+12	+13	+14	+15	+16
S000	R					R			R								
S020																	
S040																	
S060																	
S080																	
S100																	
S120																	
S140																	
S160																	
S180																	
S200																	
S220																	
S240																	
S260																	
S280																	
S300																	
S320																	
S340																	

### 6.7.4 Zoom Box

Shows the present position of the cursor magnified.

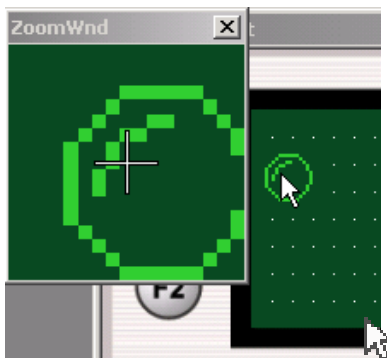

### 6.8 Screen Menu

Explains the various functions of the Screen menu.

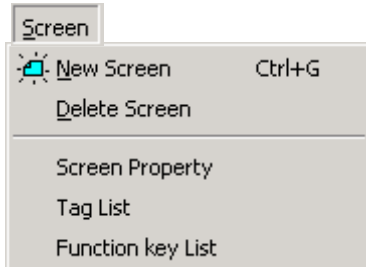

#### 6.8.1 New Screen

Click [Screen → New screen] to create a new screen, then a Create New Screen window will be displayed.

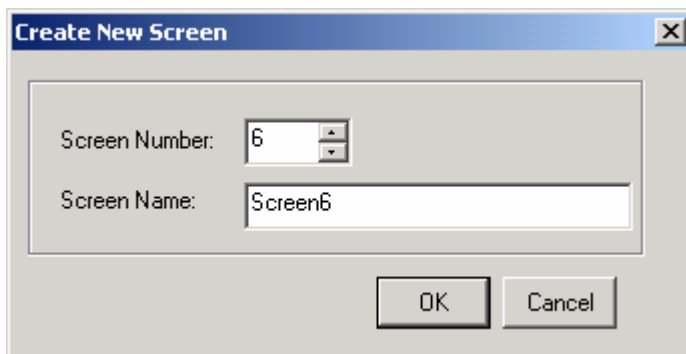

Input the number and the name of the new screen and click [OK].

You can see a new screen is created on the screen windows.

#### 6.8.2 Delete Screen

- 1) Select the screen to delete in the project window (or in the Screen Edit Window) and click 『Screen Delete』 in the Screen Menu to delete the selected screen.
- 2) The Edit Functions of New Screen, Delete Screen, Copy Screen, Cut Screen and Paste Screen are also available with the Shortcut Keys in the project window.

Shortcut Key	Function
Ctrl + C	Copy
Ctrl + X	Cut
Ctrl + V	Paste

### 6.8.3 Screen Property

Displays the property of the screen presently worked on, where the screen number and name, previous screen No., following screen No. and background image are displayed as specified. For more information refer to '6.3.1 Screen Edit Window'.

### 6.8.4 Tag List

Click 『Tag List』 in the Screen Menu to display the property of the tag used in the present window per item as shown below.

No.	X	Y	Ch	Stat.	Address	Font	Color Reverse	Outline	Write Enabled	Signed	Password Use	Max	Min	Byte	Base	Tot Digit	Fract Digit	0 Fill
1	10	14	5	0	0	M	<input type="checkbox"/>	<input type="checkbox"/>	<input checked="" type="checkbox"/>	<input type="checkbox"/>	<input type="checkbox"/>	65535	0	W	DEC	5	0	<input type="checkbox"/>
2	15	34	5	0	0	M	<input type="checkbox"/>	<input type="checkbox"/>	<input type="checkbox"/>	<input checked="" type="checkbox"/>	<input type="checkbox"/>	32767	-32768	W	DEC	5	0	<input type="checkbox"/>
3	64	50	5	0	0	M	<input checked="" type="checkbox"/>	<input checked="" type="checkbox"/>	<input type="checkbox"/>	<input type="checkbox"/>	<input type="checkbox"/>	65535	0	W	DEC	5	0	<input type="checkbox"/>

## Chapter 6. Panel Editor

### 6.8.5 Function key List

Click 『Function Key List』 in the Screen Menu to display the function designated for the Function Key in the present screen as shown below.

Function Key List : Motor ( ID = 1 )								
[ Function Key F1 ]	Value input	Ch	Stat.	Address	asswordUse			
Bit	Momentary On	S	0	00	<input type="checkbox"/>			
[ Function Key F2 ]	Value input	Ch	Stat.	Address	asswordUse	Byte	Base	Signed
Drive Out	0	S	0	0	<input type="checkbox"/>	W	DEC	<input type="checkbox"/>
[ Function Key F3 ]	Value input	Ch	Stat.	Address	asswordUse	Byte	Base	
Increment	0	S	0	0	<input type="checkbox"/>	W	DEC	
[ Function Key F4 ]	Value input	Ch	Stat.	Address	asswordUse	Byte	Base	
Decrement	0	S	0	0	<input type="checkbox"/>	W	DEC	
[ Function Key Upward ]	Screen number	asswordUse						
Screen	1	<input checked="" type="checkbox"/>						
[ Function Key Downward ]								
None								
[ Function Key Leftward ]								
None								
[ Function Key Rightward ]								
None								

Close

## 6.9 Tag Menu

The following explains about various tags.

XGT Panel supports 10 kinds of tags. There are some differences in properties of tags according to PLC type to connect to, and the example of this manual is for LS MASTER-K series.

Tag(O)		
123 Numeric		F2
Message		F3
Button		F4
Lamp		F5
Bar Graph		F6
Trend Graph		F7
Pie Graph		F8
Rotate		F9
Move		F11
Clock		F12

### 6.9.1 Numeric Tag ( 123 )

Displays a device value of PLC or writes value to the device.

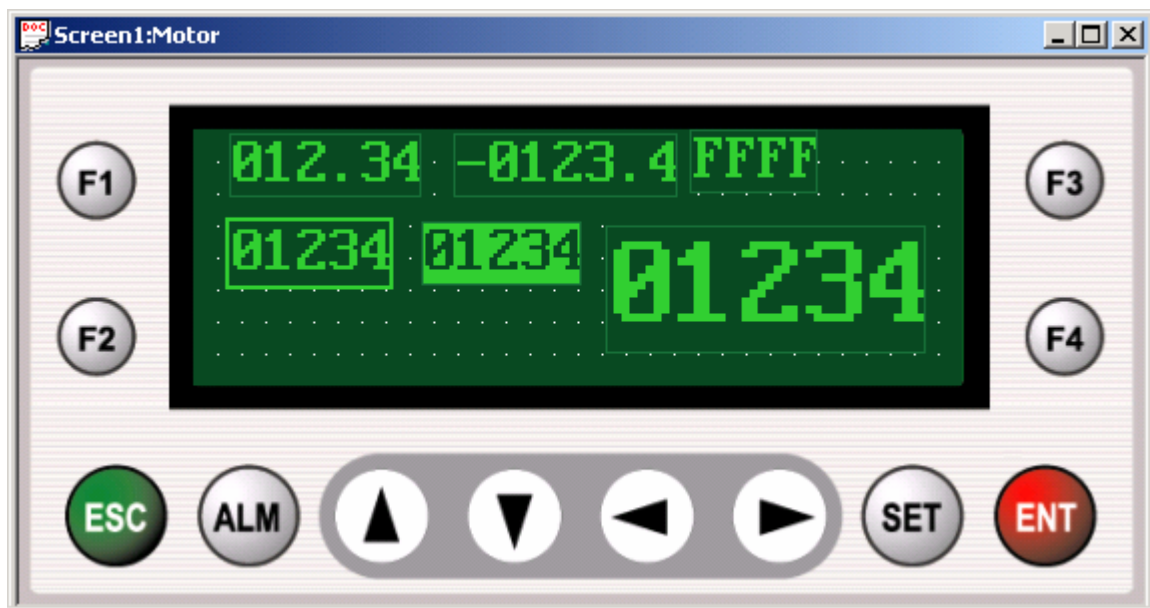



## Chapter 6. Panel Editor

In order to specify the property of the numeric tag, double-click the numeric tag to display the Numeric Property setting window of the tag as below.

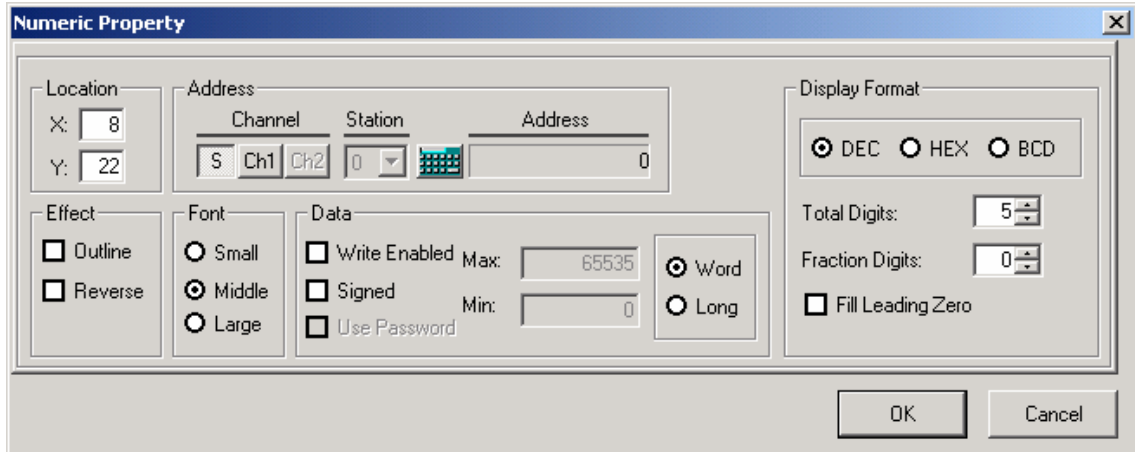

### 1) Location

- (1) Displays or specifies the X, Y coordinates of the numeric tag. (Max. X: 191, Y: 63)
- (2) Thereupon, the X, Y coordinates point at the left upper edge of the tag.
- (3) Drag the tag with the mouse to move the tag, when the coordinates will change automatically.

### 2) Effect

- (1) Outline: displays the outline of the numeric tag in solid line.
- (2) Reverse: Reverses the tag's color.

### 3) Font

- (1) Small: Changes the size of the character to 6 x 8 dots.
- (2) Middle: Changes the size of the character to 8 x 16 dots.
- (3) Large: Changes the size of the character to 16 x 32 dots.

### 4) Address



- (1) Channel: Specifies the communication channel of the data to display.
  - a) S: Specifies the system memory device of the XGT Panel.
    - A system memory is the memory to be provided for the user, and allows the user to use. With block communication or calculation function, the data value can be processed to use or a special buffer can be applied inside.
    - The size of system memory is 1,000 Word (0~999) , and you can use 900 Word (0~899) as user memory area.

## Chapter 6. Panel Editor

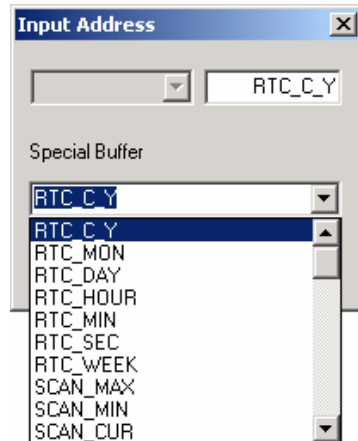
- For more information on latch Area, refer to Parameter Setting in the Common Resource menu. S900~S999 is a system flag area. And refer to the appendix for details about system flags.
- After 『S』 is selected, click , then internal device addresses or special flags can be selected as shown below.



b) Ch 1: specifies the RS-232C channel of the XGT Panel.

Select 『Ch 1』, and click  to specify a device and input an address as shown below. (• Click , then the following window appears for the user to input an address)

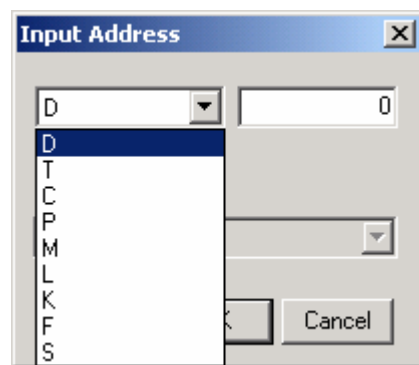

c) Ch 2: sets the devices of the instruments connected to RS-422/485 communication of the XGT Panel. Select 『Ch 2』, and click  to specify a device and input an address as shown above.

(2) Station No.: If Ch 1 or Ch 2 is selected, it will be activated and will set the other Station No. for the correspondent numeric tag to communicate with. The default value will be the slave Station No. which was set when the project was created.

## Chapter 6. Panel Editor

### 5) Data

(1) Max. value: will be active only if 『Write Enabled』 is selected, where the max. value available to input should be set.

Any value more than the set maximum can not be input.

The range available to set is as shown in the table below.

(2) Min. value: will be active only if 『Write Enabled』 is selected, where the min. value available to input should be set.

Any value less than the set minimum can not be input.

Data		Range	
Display Format	Type		
DEC	Word	Signed	-32768 ~ 32767
		Unsigned	0 ~ 65535
	Long	Signed	-2147483648 ~ 2147483647
		Unsigned	0 ~ 4294967295
HEX	Word	0 ~ FFFF	
	Long	0 ~ FFFFFFFF	
BCD	Word	0 ~ 9999	
	Long	0 ~ 99999999	

(3) Write Enabled: allows the value to change with the key in the XGT Panel.

Whenever the SET key is pressed, it searches for the tag where 『Write Enabled』 is selected in the present screen and displays the cursor in sequence. The display sequence of the cursor is from the left upper to the right bottom of the screen. In order to change the value, use the left/right direction keys (◀, ▶), moving the number of ciphers, change the value with the up/down direction keys (▲, ▼) and then press the ENT key to write the set value on the applicable address. The set value will not be set if not appropriate.

(4) Signed: will be active only if the display type is of the decimal system, allowing the negative number to be displayed.

(5) Use Password: will be active only if 『Write Enabled』 is selected. If Use Password is selected and a password is set to the XGT Panel at the same time, the cursor will not be displayed despite the set key pressed.

The tag which has set Use Password is available to write only if the password is cancelled in the XGT Panel.

(6) Word/Long: sets the data type of the tag.

Word: 2 bites, Long: 4 bites

## Chapter 6. Panel Editor

### 6) Display Format

- (1) DEC: displays the read data in the decimal.
- (2) HEX: displays the read data in the hexadecimal.
- (3) BCD: displays the read data in the binary-coded decimal.
- (4) Number of the total digits: sets the number of the total digits to display.

If the actual data exceeds the number of the digits which has been set, only the number of the digits as many as set based on the lower digit will be displayed.

Ex.) If the read device is 12,345 and the number of the total digits is set to be 3,

-> Actual screen display: 345.

- (5) Number of the fraction digits: will be active only if the display type is set DEC, displaying the number of the fraction digits. At this moment, the read value is not scaled up or down but just displayed with the decimal point.

Ex.) If the read device is 12345 and the number of the fraction digits is set to be 2,

-> Actual screen display: 123.45.

		Max. number setting available		Display Format of Numeric Tag
		Number of the total digits	Number of the fraction digits	
Word	DEC	5	4	0.1234
	HEX	4	Not specified	FFFF
	BCD	4	Not specified	0123
Long	DEC	10	9	0.123456789
	HEX	8	Not specified	FFFFFFFF
	BCD	8	Not specified	10234567

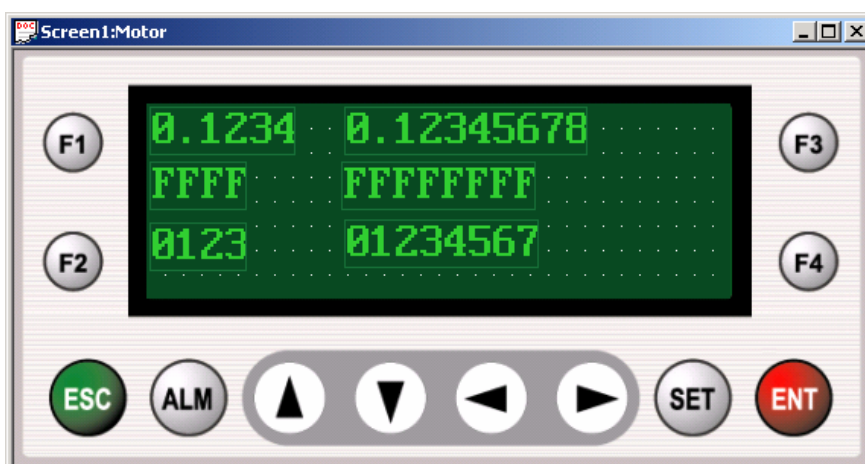

- (6) Outline: displays the outline of the tag in solid line.
- (7) Fill Leading zero: fills the number of the digits with "0" if there is no higher value when the numeric tag moves.

Ex.) If the read device is 123 and Fill Leading zero is selected,

-> Actual screen display: 00123.(in case the number of the total digits is 5)

## Chapter 6. Panel Editor

### 7) Application example of the numeric tag

#### (1) System Configuration

- In case of 1:1 communication with Master K120S through RS-485 where the XGT Panel is set to be a master.

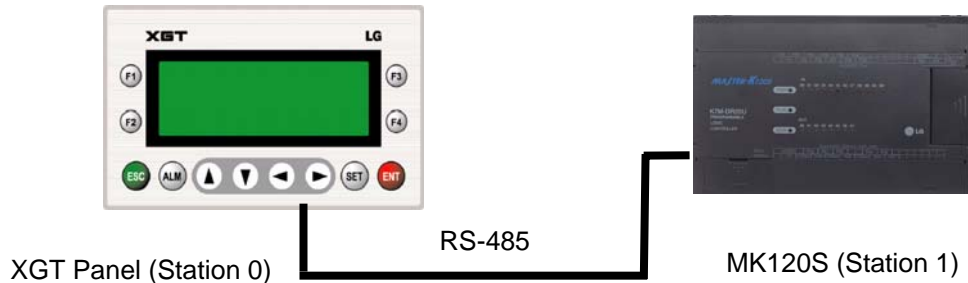

(2) After the Panel Editor is executed, select Ch 2 as LS:MASTER-K (Link) in the project management and then let the communication set aligned to MASTER-K120S.

#### (3) Numeric Tag Setting

Select the numeric tag in the Panel Editor and specify the property of the tag as shown below.

Setting Item	Setting Value	Setting Item	Setting Value
Channel	Ch2 (RS-422/485)	Display Format	DEC
Station No.	1	Total Digits	5
Address	D0000	Fraction Digits	0
Outline	Not specified	Fill Leading 0	Specified
Color Reverse	Not specified	Write Enabled	Specified
Font	Middle	Max.	65535
Data	Word	Min.	0

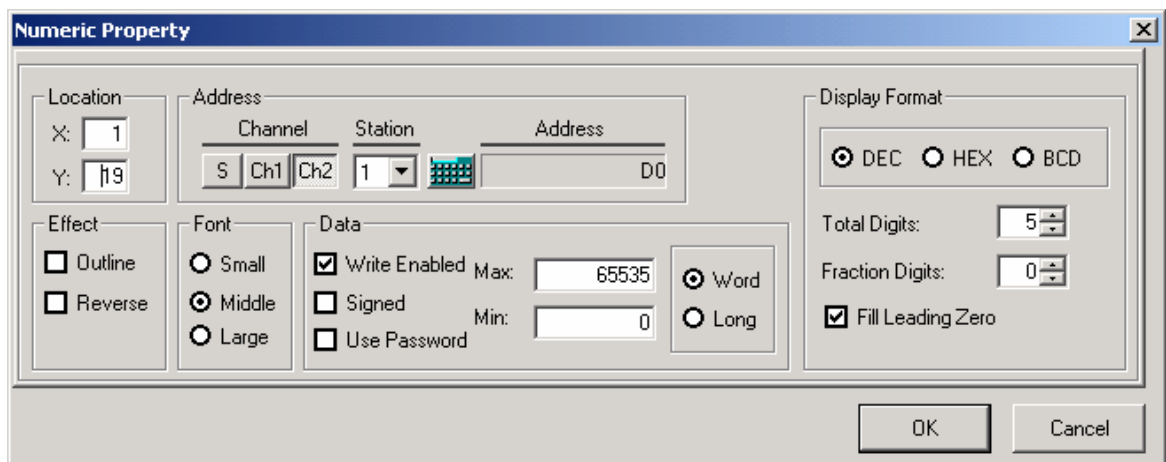

## Chapter 6. Panel Editor

### (4) Download

Downloads the project drawn on the XGT Panel. See the communication menu for details on download.

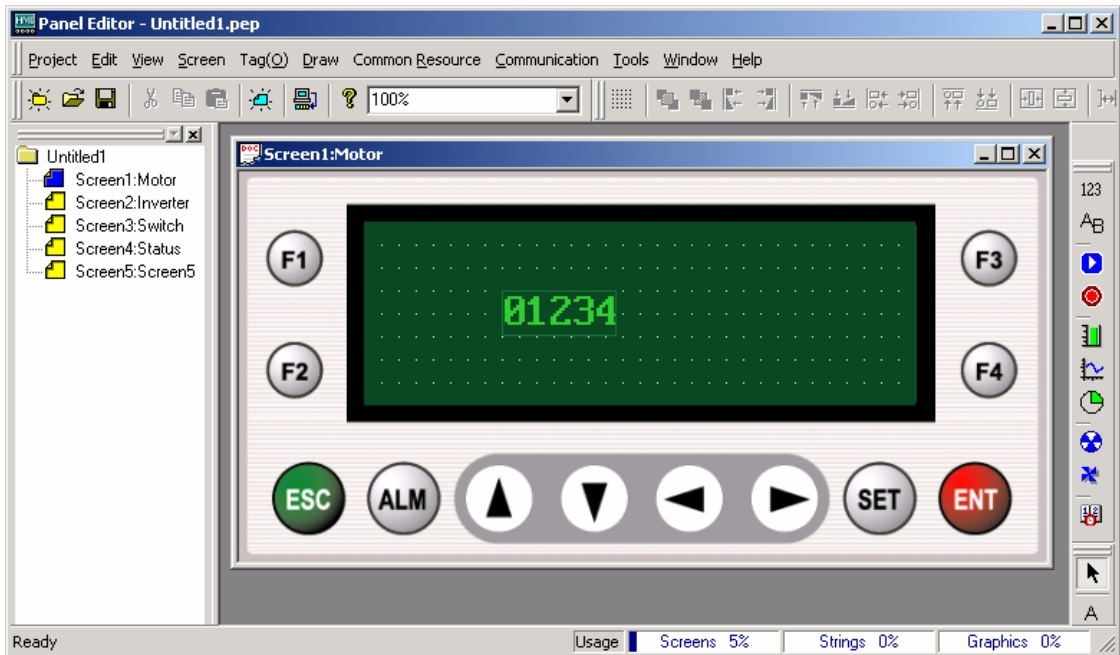

### (5) Write Example of the Numeric Tag

In case the presently read value is 12345 which will be changed.

- Value of the numeric tag where Write Enabled is specified presently displays 12345.

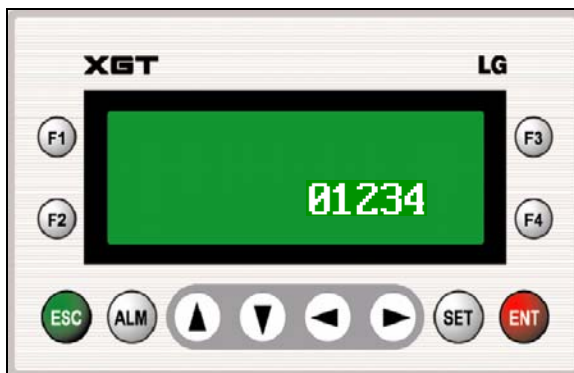

(1) If SET key is pressed, the cursor will blink on 1 digit of the numeric tag.

Key	Display	Remarks
SET	1 2 3 4 <b>5</b>	Cursor blinks if Write Enabled specified

## Chapter 6. Panel Editor

(2) If ◀ key is pressed, the cursor will ascend to 10 digits.

Key	Display	Remarks
◀	1 2 3 4 5	Number of the digits ascended (Cursor blinks)

(3) If ▶ key is pressed, the cursor will descend to 1 digit again.

Key	Display	Remarks
▶	1 2 3 4 5	Number of the digits descended (Cursor blinks)

(4) If ▲ key is pressed, the value on 1 digit will increase by 1, displaying 12346. However, the changed value is not transferred to PLC yet this moment.

Key	Display	Remarks
▲	1 2 3 4 6	Setting value increased by 1 (Cursor blinks)

(5) If ▼ key is pressed, the value on 1 digit will decrease by 1, displaying 12345. However, the changed value is not transferred to PLC yet this moment.

Key	Display	Remarks
▼	1 2 3 4 5	Setting value decreased by 1 (Cursor blinks)

(6) If ▲ key is pressed twice again, the value on 1 digit will increase by 2, displaying 12347.

Key	Display	Remarks
▲	1 2 3 4 7	Setting value increased by 2 (Cursor blinks)

(7) If ENT key is pressed, the present setting value of 12347 will be written by D0000 on the PLC. And the cursor will disappear.

Key	Display	Remarks
ENT	1 2 3 4 7	Write setting value(Cursor disappears)

- If there is no response from the connection instrument while writing or there is NAK response, Re-Write is not available. That is, Write is executable just one time.

## Chapter 6. Panel Editor

### 6.9.2 Message Tag ( )

Displays a registered message according to the value of device.

Displays blank if a registered message for the current value of the device does not exist.



In order to specify the property of the message tag, double-click the message tag to display the Message Property setting window as shown below.

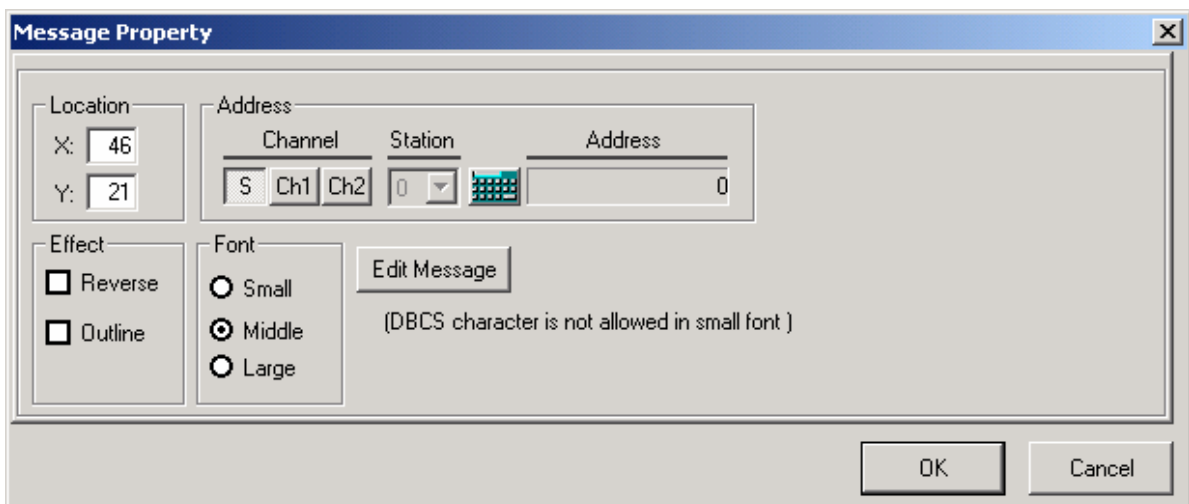

#### 1) Location

- (1) Indicates tag's location (X-axis: 0~191, Y-axis: 0~63).
- (2) Thereupon, the X,Y coordinates point at the left upper edge of the tag.



## Chapter 6. Panel Editor

---

- (3) Drag the tag with the mouse to move the tag, when the coordinates will change automatically..
- (4) Relocating is available by dragging the mouse.

### 2) Effect

- (1) Outline: Displays the outline of the numeric tag in solid line.
- (2) Reverse: Reverses the tag's color.

### 3) Font

- (1) Small: Changes the size of the character to 6 x 8 dots.
- (2) Middle: Changes the size of the character to 8 x 16 dots.
- (3) Large: Changes the size of the character to 16 x 32 dots.

### 4) Address

- (1) Refer to the section '6.9.1 Numeric Tag' for details.

### 5) Edit Message

- (1) Edits the details of the message tag according to the change of the device of the instrument connected.
- (2) Click 'Message Edit' in the property setting window to display the Message Edit screen as shown below.

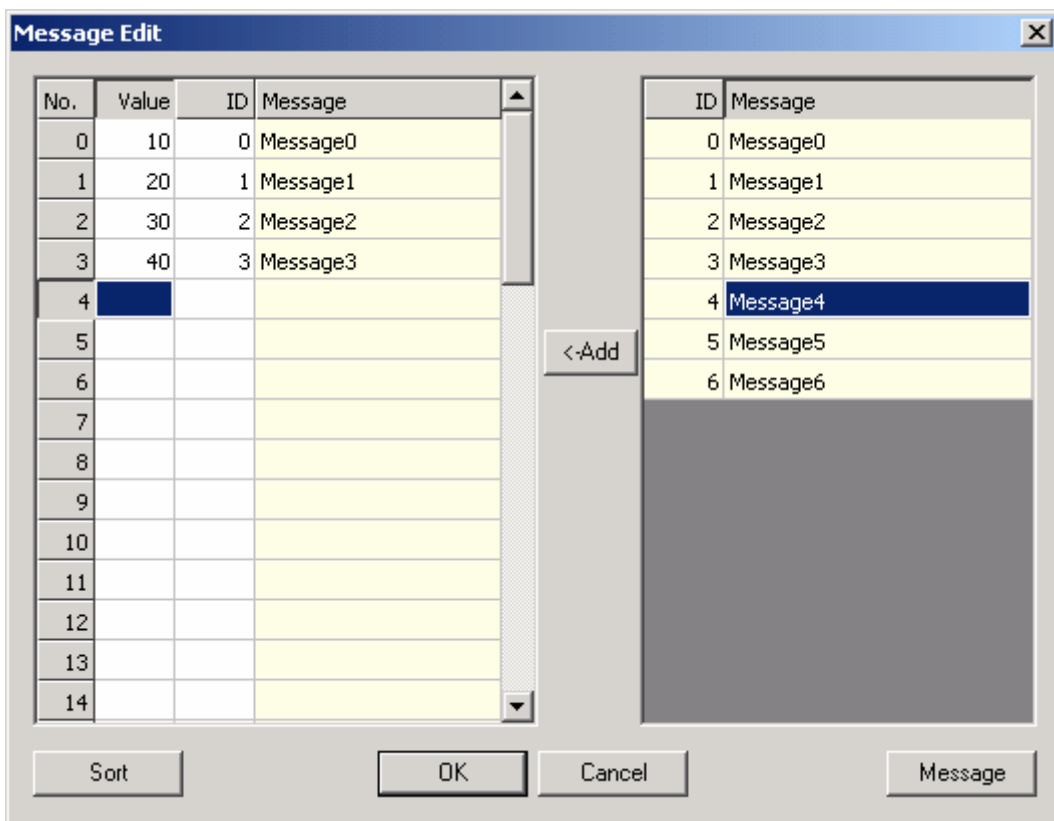

## Chapter 6. Panel Editor

---

- (1) Message List (Right grid): Shows the contents and ID of all messages.
- (2) Message List (Left grid): Shows the messages which are registered for the selected message tag.

Up to fifty messages can be registered to one message tag.

If the value of the device specified is identical to that of the message registered, its applicable message will be displayed. For example, if the value of the device is 20, 'Message 3' will be displayed on the XGT Panel and if the value of the device is 35, 'Message 4' will be displayed. All messages have to contain ID and device value.

- (3) Add: Registers the messages on the whole message lists in the left message tag.
- (4) Sort: Aligns registered messages by [Value].
- (5) Cancel: Cancels a message editing.
- (6) OK: Completes a message editing.

### 5) Message Management

Lets the messages added, deleted, updated on the whole message lists.

Click Message Management button to display the Message Management window as shown below.

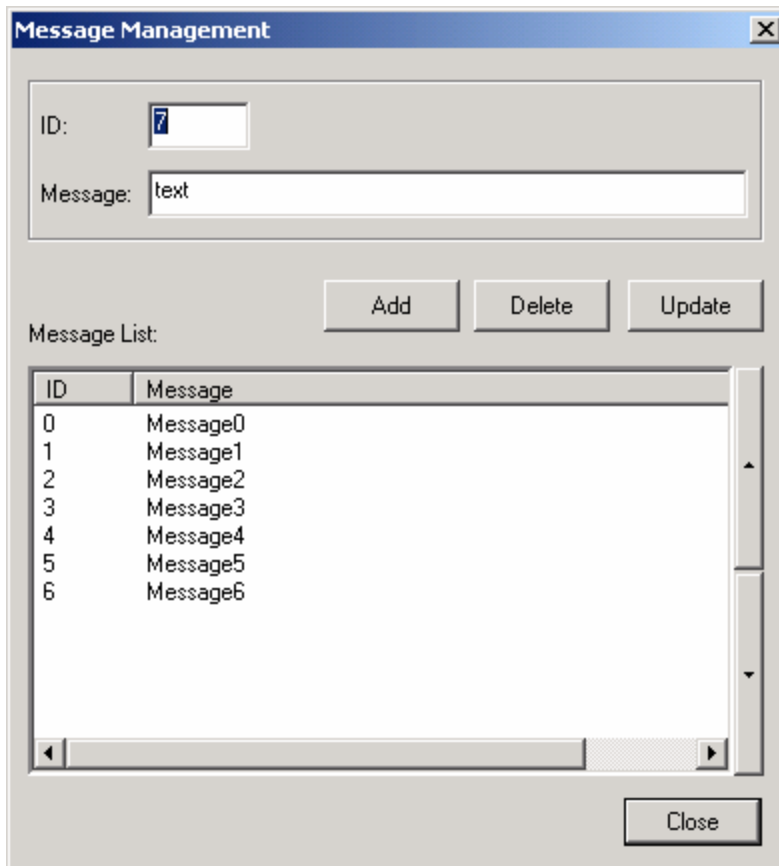

- (1) Add: Click Add button after the ID and contents of a message newly to add are input so to add the message on the registered message list at the bottom, where available range of ID is 0-65535 with the contents of the message up to 24 English characters and 12 Korean characters available.  
In addition, the total number of messages differs according to the length of the contents of the message registered, which can be confirmed in the memory usage quantity in the View menu.
- (2) Delete: Select a message to delete among the registered messages and click the Delete button

## Chapter 6. Panel Editor

to delete the selected message.

- (3) Update: Select a message to update among the registered messages, input ID and contents to update and click the Update button to update the selected message.

### 6.9.3 Button Tag ( )

Displays and controls a status (On or Off) of bit device.

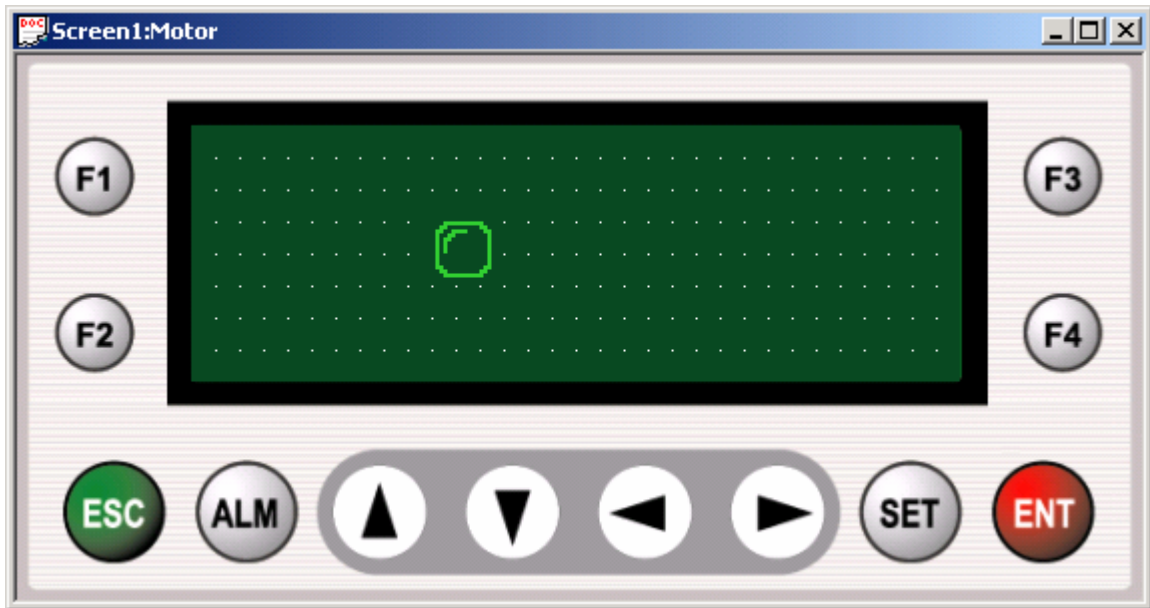

In order to specify the property of the Button Tag, double-click Button Tag to display the Property setting window as shown below.

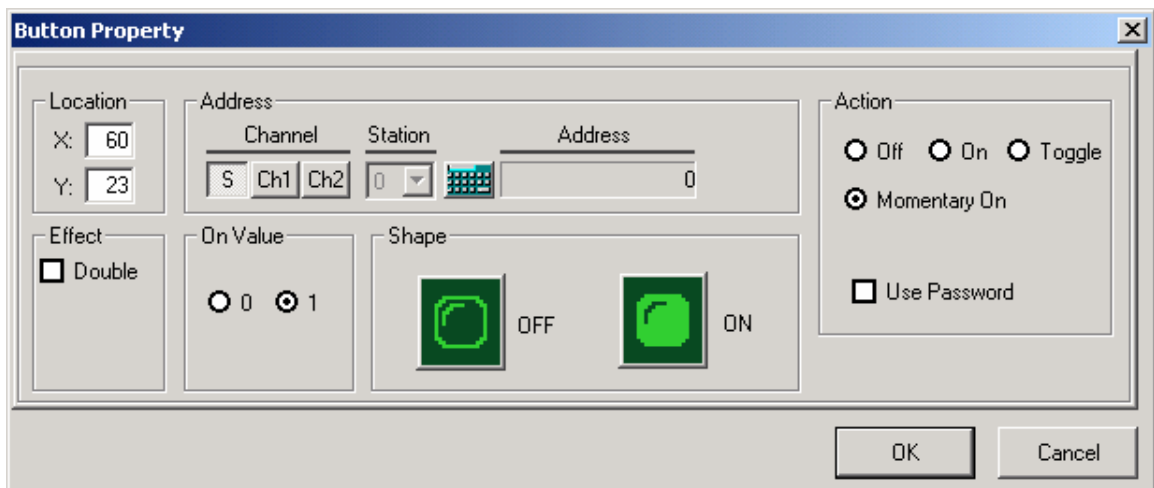

## Chapter 6. Panel Editor

---

### 1) Location

- (1) Indicates tag's location (Max. X:191, Y: 63).
- (2) Thereupon, the X,Y coordinates point at the left upper edge of the tag.
- (3) Drag the tag with the mouse to move the tag, when the coordinates will change automatically.
- (4) Relocating is available by dragging the mouse.

### 2) Effect

- (1) Double: Changes the size of the character to double.

### 3) On Value

- (1) Specifies the display format according to the value of the read device status.
- (2) If On status is set 0, On display format will be displayed when the value of the read device is 0, and if set 1, Off display format will be displayed.
- (3) If On status is set 1, Off display format will be displayed when the value of the read device is 0, and if set 1, On display format will be displayed respectively.

### 4) Address

- (1) Channel: Specifies the data's communication channel to display.

- ① S: Specifies a system memory of the XGT Panel.

- A system memory is the memory to be provided for the user, and allows user to use as user memory or as system flags
- The size of system memory is 1,000 Word (0-999), and the user can use 900 Words (0-899) as user memory area. As for XP10BKB/DC, a latch area can be specified.

For more information on the latch area, refer to Parameter Setting of the Common Resource menu.

S900~S999 is the system flag area. For more information on the system flag, see the appendix.

After 『S』 selected, click  to choose an internal device address or a special flag as shown below. •

Click , then the following window appears for the user to input an address or system flag.

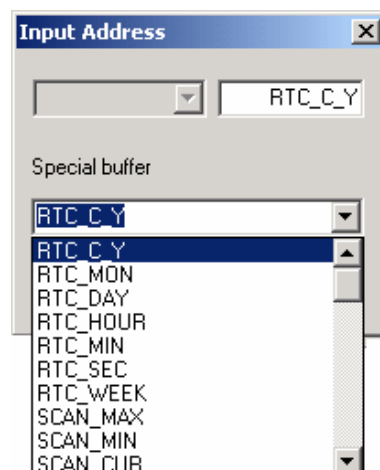

## Chapter 6. Panel Editor

- Add the bit position at the back of the word address to specify a specific bit of a system memory.

(Example) 8<sup>th</sup> bit of 120<sup>th</sup> word: 1208

12<sup>th</sup> bit of 700<sup>th</sup> word: 700C

If a special buffer is specified, it will be set to the lowest bit of the applicable special buffer.

### ② Ch 1

- Specify the channel as Ch 1(RS-232C).
- Click , then the following window appears for the user to input an address to read.

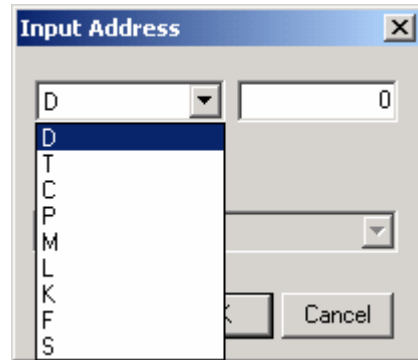

### ③ Ch 2

- Specify the channel as Ch 2 (RS-422/485).
- After 『Ch 2』 selected, click  to specify a device and input an address as shown above.

(2) Station: will be active if Ch 1 or 2 selected, where the communication Station No. of the correspondent will be set.

The Station No. which has been set in the communication setting of the file menu will be displayed as default.

### 5) Action

Specifies the actions of button tag if it is selected

Action	Description	Remark
On	Device value "1" Write(1 time)	1) Choose tag by "SET" key. 2) Operate by "ENT" key.
Off	Device value "0" Write(1 time)	
Reverse	Present status of device value reversed	
Momentary On	Only while pressing, "1" Write If key input turned off, "0" is written on the applicable device.	

### 6) Use password

When the password is used, Write Action is disabled until it is cleared.

## Chapter 6. Panel Editor

### 7) On Value & Shape

- (1) Specifies the display shape of the button tag according to On/Off status of the device.
- (2) If the value of the device is 0, Off shape will be displayed, and if the value of the device is 1, On shape will be displayed.
- (3) The image of the display shape can be changed as requested by the user.
- (4) See Chapter 6.3 for details on Image Edit and Add of the display shape.

### 6.9.4 Lamp Tag ( )

Displays a status (On or Off) of bit device.

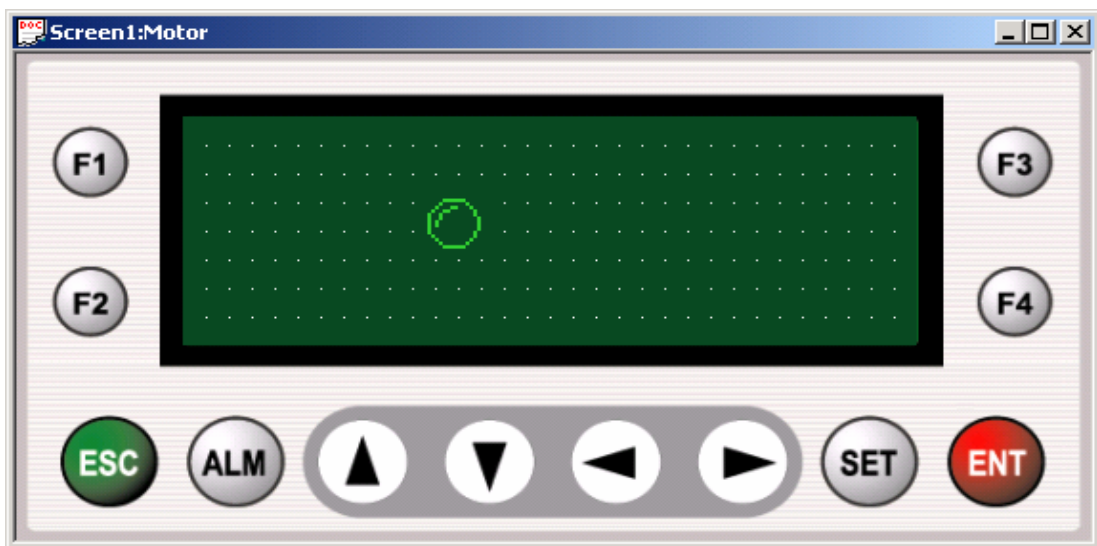

In order to specify the property of the Button Tag, double-click Button Tag to display the Property setting window as shown below.

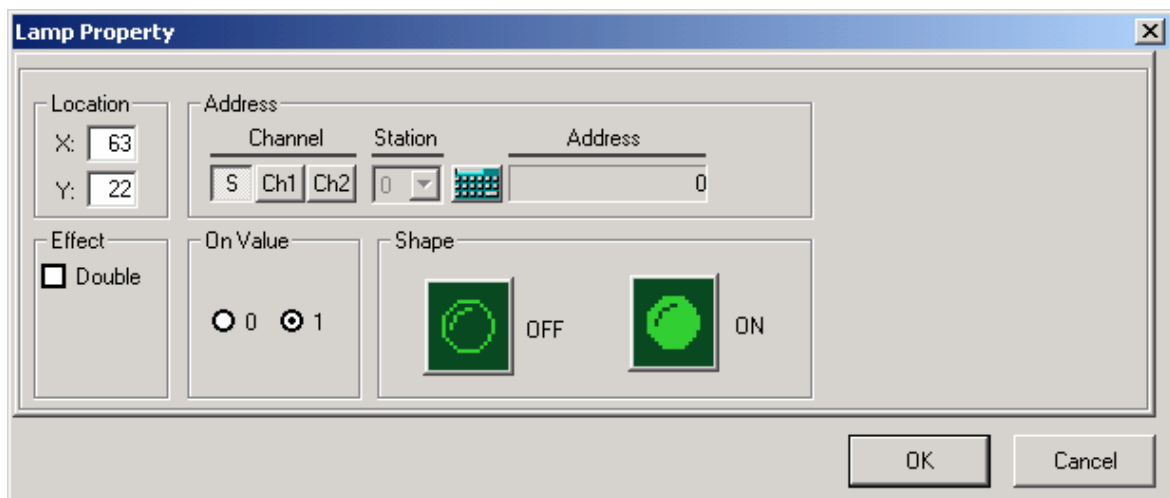

The Location, Effect, Address, On Value and Display Shape in the Lamp Property should be set identical to '6.9.3 Button

## Chapter 6. Panel Editor

Tag'.

### 6.9.5 Bar Graph Tag ( )

Displays current value of device with a shape of bar graph

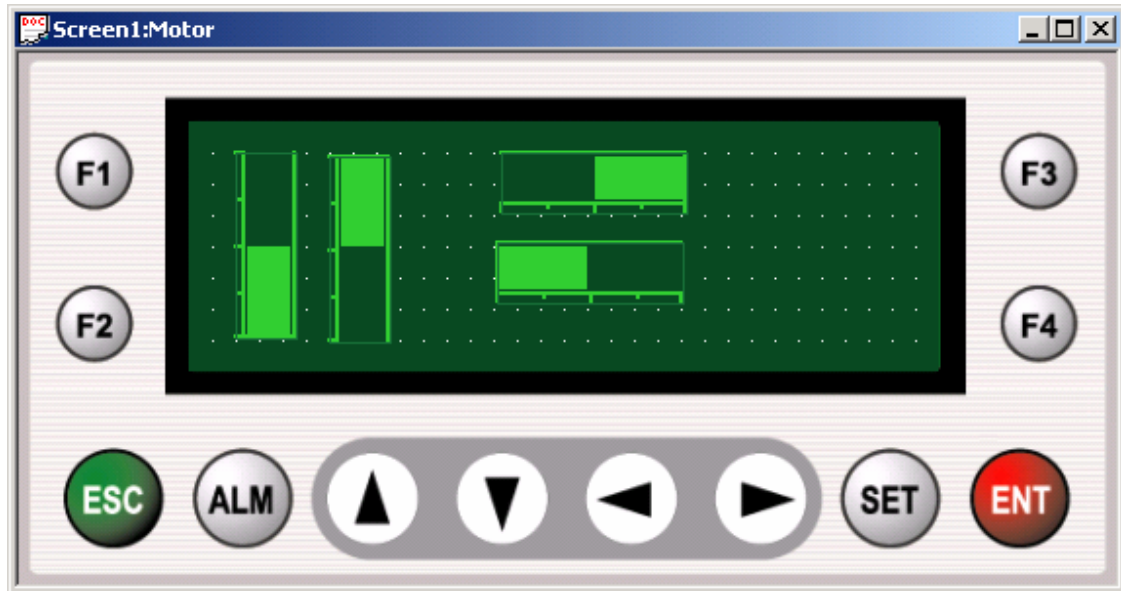

In order to specify the property of the Bar Graph Tag, double-click Bar Graph Tag to display the Bar Graph Property setting window as shown below.

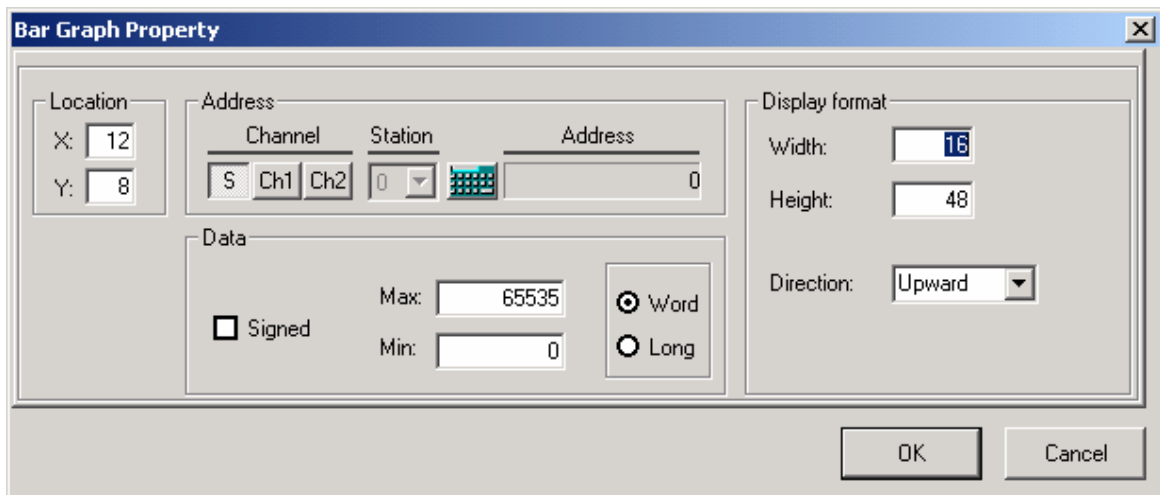

The Location, Address, and Data in the Bar Graph Property should be set identical to '6.9.1 Numeric Tag'.

#### 1) Graph

(1) Width: Specifies the width of the bar graph.

-. Available range 8 ~ 192.

## Chapter 6. Panel Editor

- Any other value than specified above will not be set.

(2) Height: Specifies the height of the bar graph.

- Available range 8 ~ 64.

- Any other value than specified above will not be set.

(3) Size Edit by using the mouse

- Select a bar graph tag to edit and use the mouse to change the size of the graph tag.

- Width and Height will be changed automatically at this moment.

(4) Display Direction : Specifies the increasing direction according to the increase of the read device value.

- One direction can be specified among Upward/Downward/Leftward/Rightward.

### 2) Example

Assume that properties of bar graph are specified as shown below.

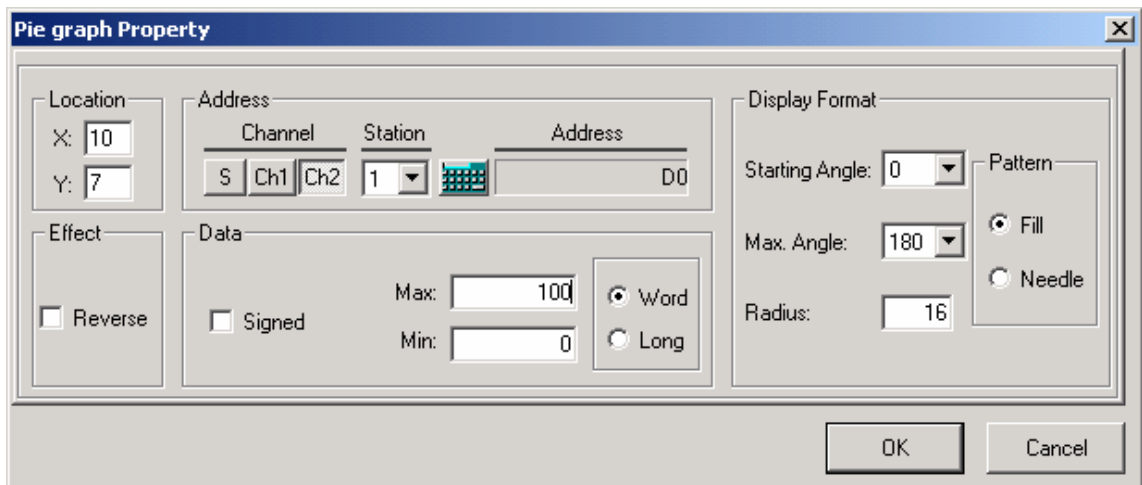

• A Bar Graph Tag operates as shown below according to the value of D0000 of the station 1 connected to Ch2.

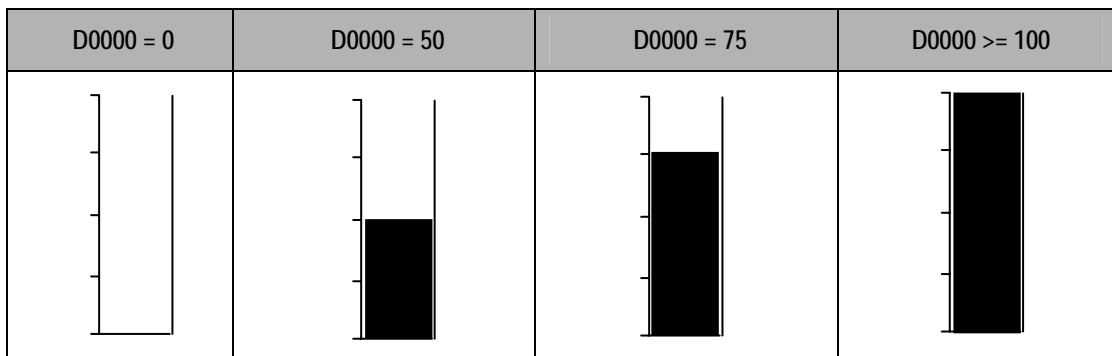



### 6.9.6 Trend Graph Tag ( )

Displays current value of device with a shape of trend graph.

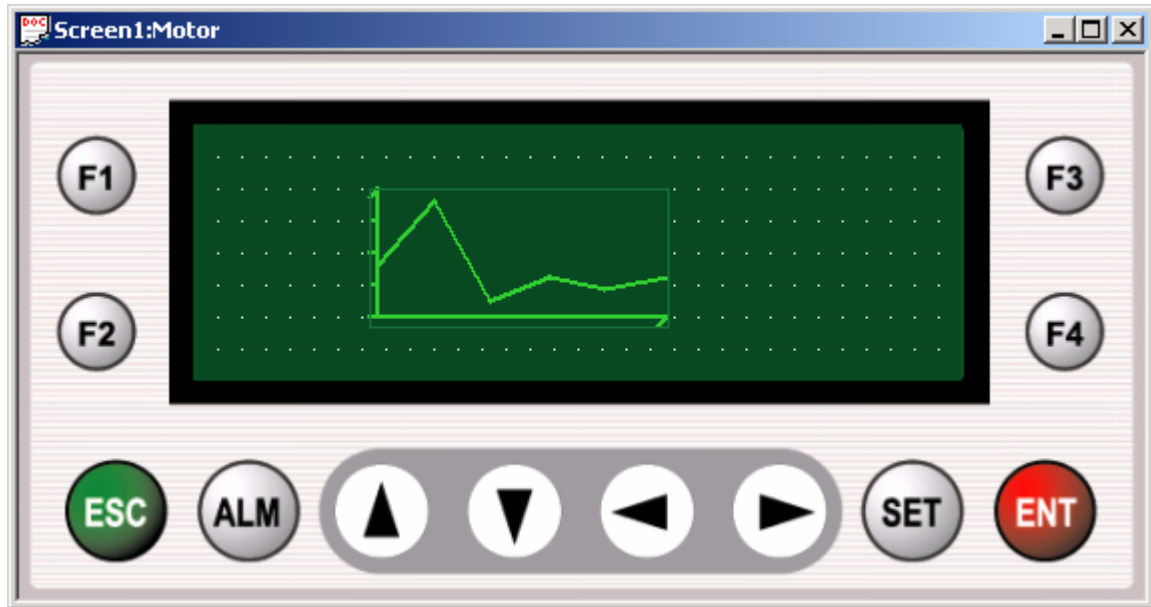

In order to specify the property of the Tag, double-click to display the Property setting window as shown below.

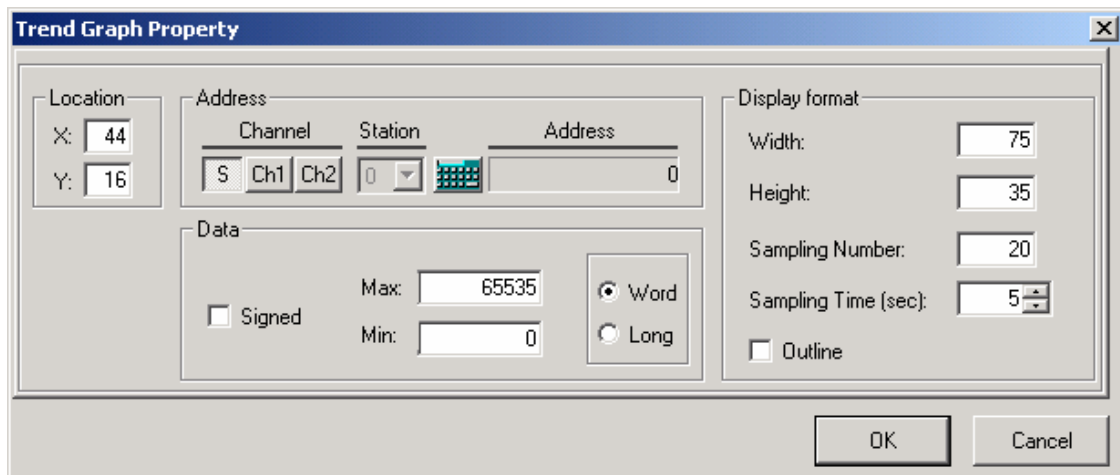

The Location, Address, and Data in the Trend Graph Property should be set identical to '6.9.5 Bar Graph Tag'.

#### 1) Graph

(1) Width: Specifies the width of the trend graph.

- Available range: 8 ~ 192

- Any other value than specified above will not be set.

## Chapter 6. Panel Editor

(2) Height: Specifies the height of the trend graph.

-. Available range: 8 ~ 64.

-. Any other value than specified above will not be set.

(3) Sampling Number

-. Specifies a maximum number of the section of X-axis. If the sampling number is set as 20,

A graph will be drawn by 1/20 of X-axis per sampling time.

(4) Sampling Time

-. Specifies a displaying time interval

-. 1~3,600 sec.

2) Example

Assume that the properties of a bar graph are specified as shown below, and the value of D0000 of Station 1 increases by 2 per second.

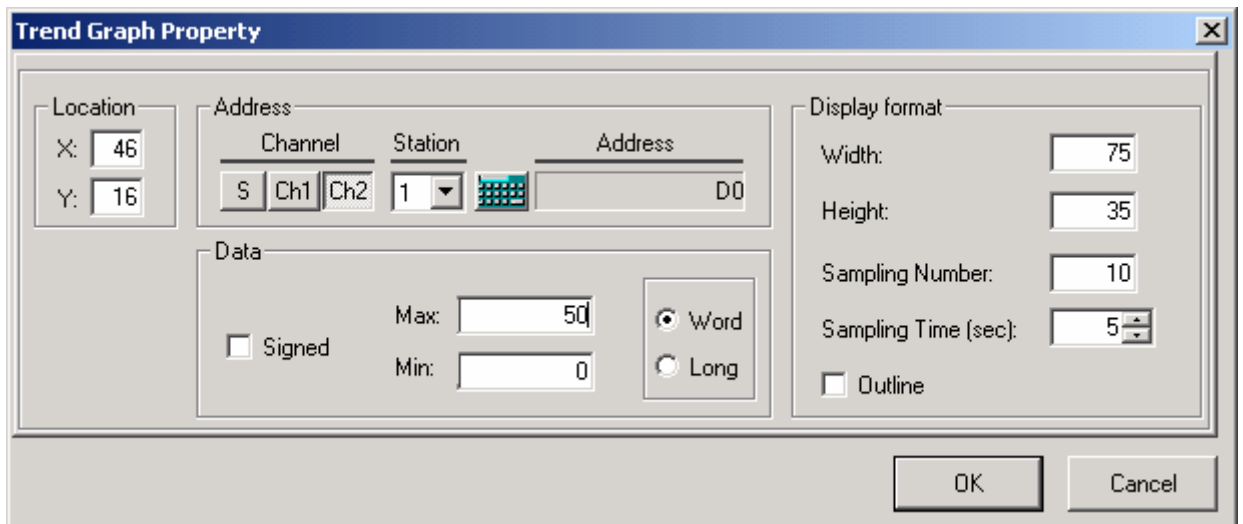

Thereupon, the Trend Graph Tag of the XGT Panel will be displayed as shown below.

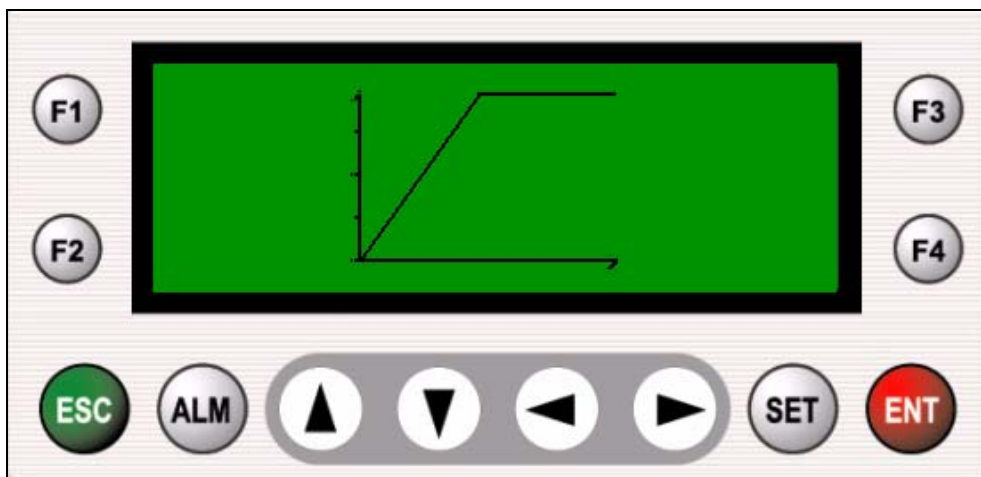

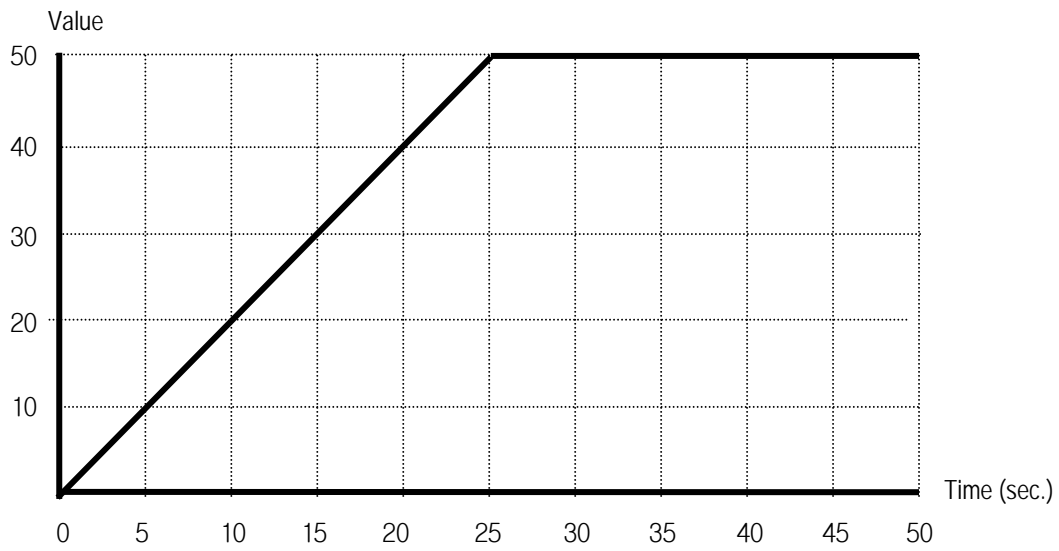

Total X-axis time = (Sampling time) x (Sampling number) = 5 x 10 = 50 sec.

### 6.9.7 Pie Graph Tag ( )

Displays current value of the devices as a shape of pie graph.

Various starting angle and displaying angle size can be specified as shown below.

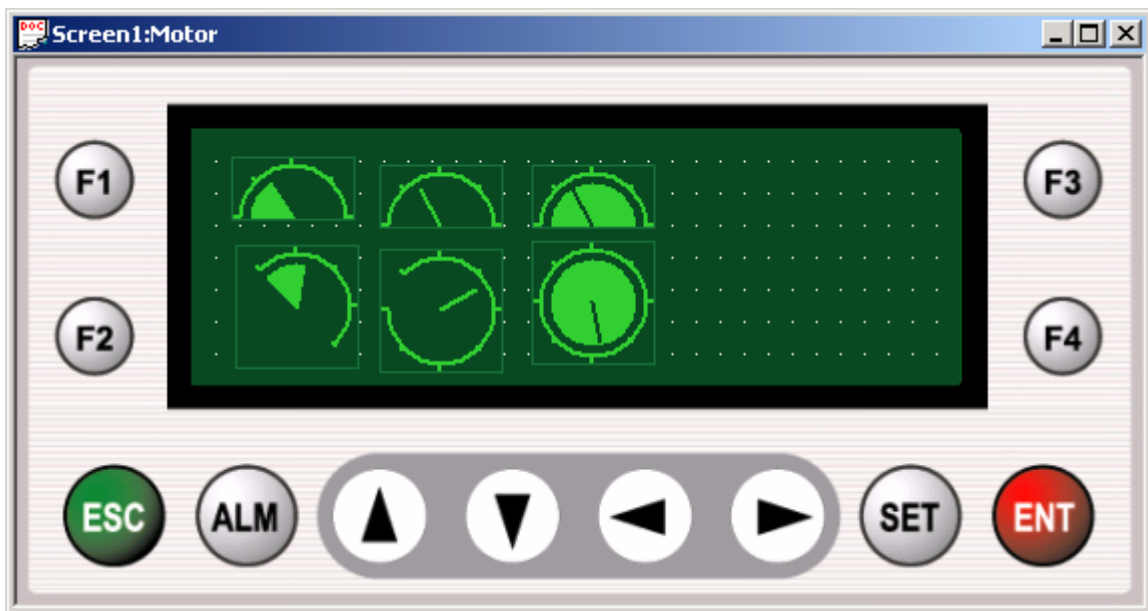

## Chapter 6. Panel Editor

In order to specify the property of the Tag, double-click to display the Property setting window as shown below.

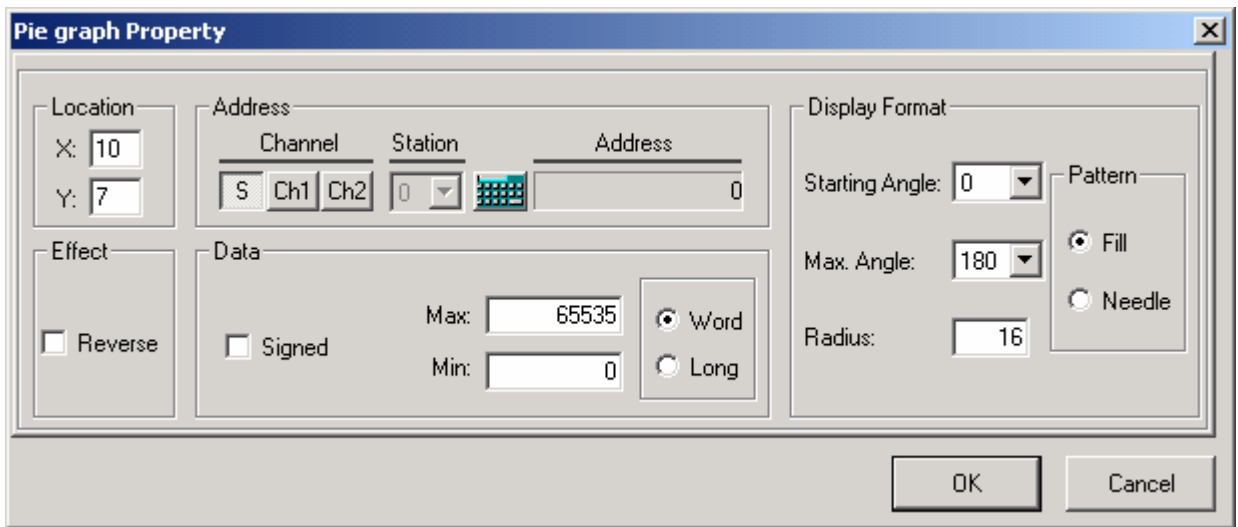

The Location, Address, and Data in the Pie Graph Property should be set identical to '6.9.5 Bar Graph Tag'.

### 1) Effect

(1) Reverse: Reverses the tag's color.

### 2) Graph

(1) Radius: specifies the radius of the Pie Graph Tag.

Use the mouse directly on the screen to change the radius of the tag.

(2) Starting Angle: specifies the Starting Angle of the Pie Graph.

Available range 0° ~ 315° by 45° increase.











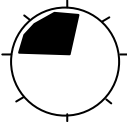



(3) Max. Angle: specifies the angle from the starting position to the ending position of the Pie Graph.

Available range 0° ~ 315° by 45° increase.

## Chapter 6. Panel Editor

### (4) Starting angle & Max. Angle

- According to various setting modes, display examples of the Starting Angle & Max. Angle are as follows.

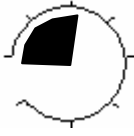
Angle (degree)	Starting Angle (Max. Angle: 180°)	Maximum Angle (Starting Angle: 0°)
0 (Starting Angle)/ 360 (Max. Angle)		
45		
90		
135		
180		
225		
270		
315		

## Chapter 6. Panel Editor

(5) Pattern: specifies the graph display pattern.

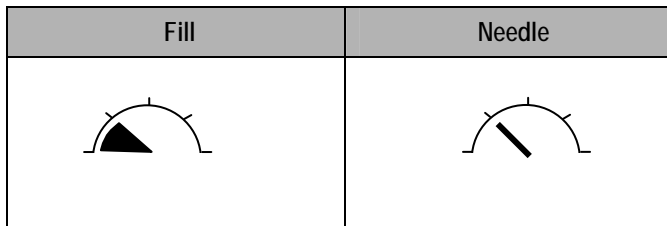

2) Example

Assume that the Property of the Pie Graph Tag is as specified below.

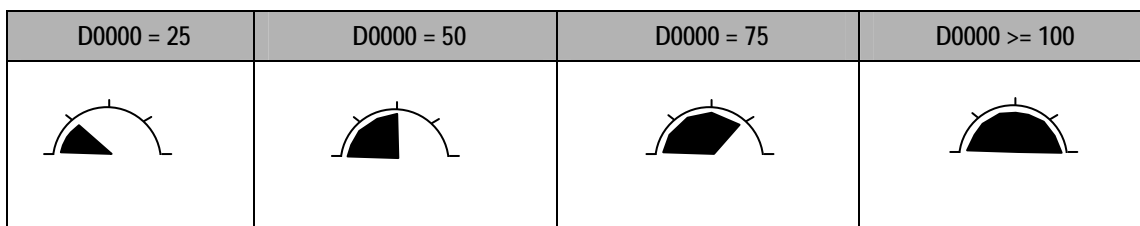
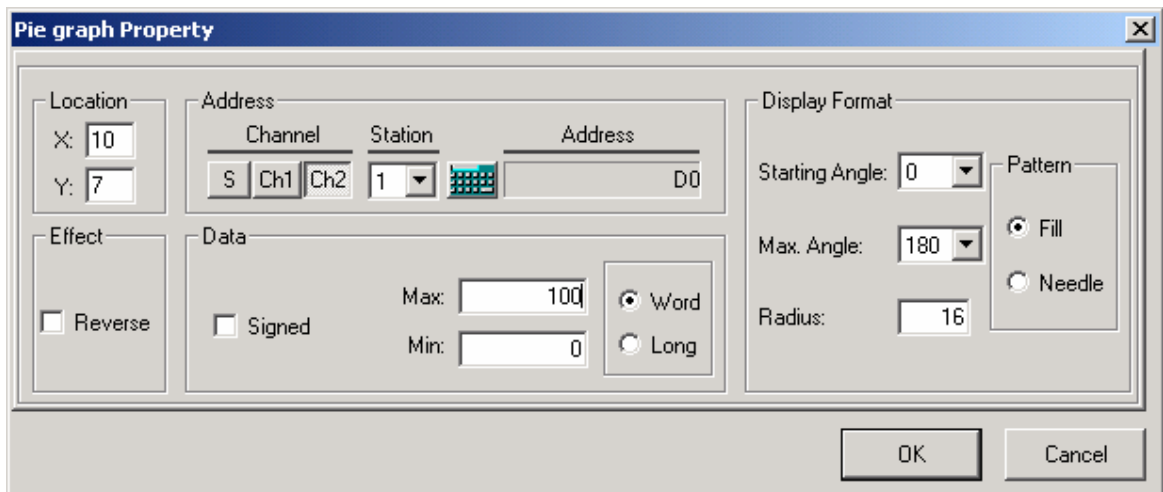

### 6.9.8 Rotation Tag ( )

Varies a rotating speed of image of motor according to the value of device.

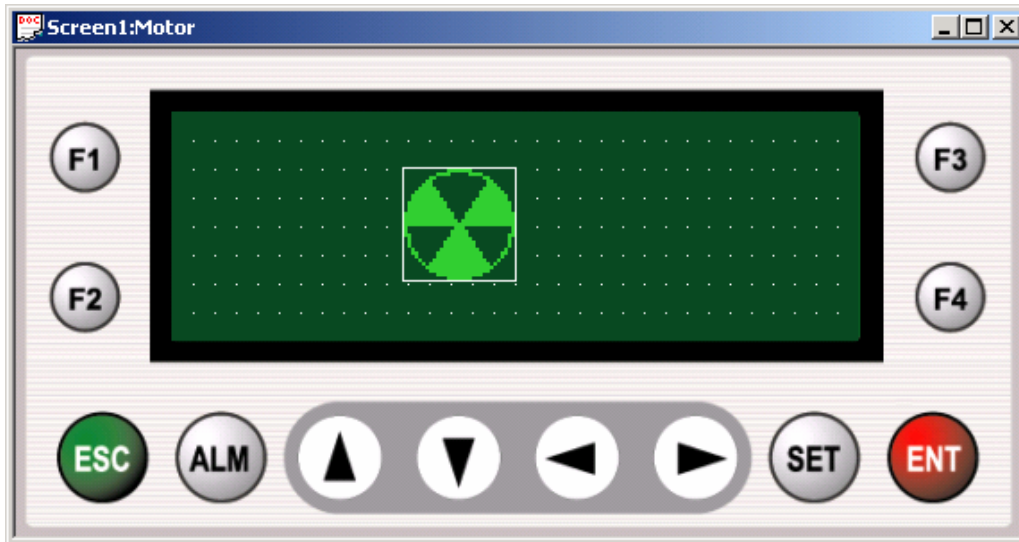

In order to specify the property of the Tag, double-click to display the Property setting window as shown below.

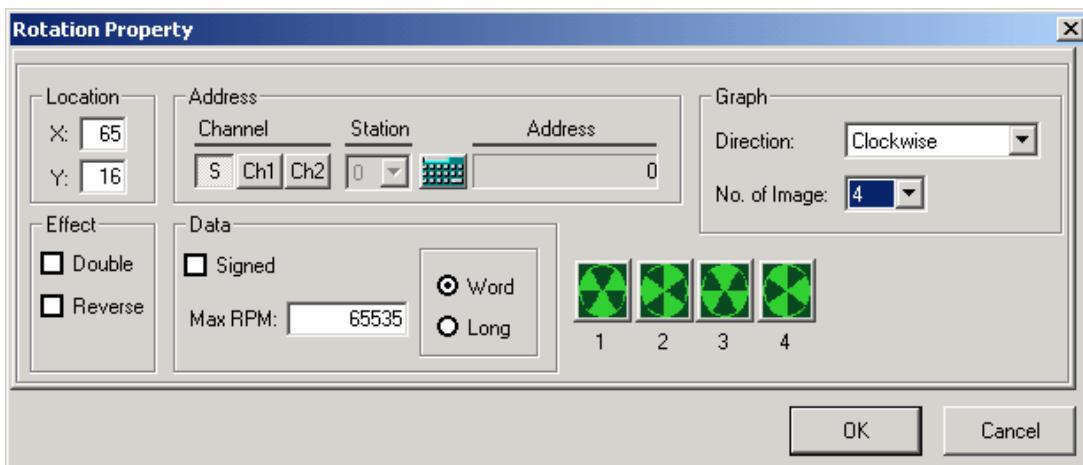

The Location, Effect and Address in the Rotation Property should be set identical to '6.9.5 Bar Graph Tag'.

#### 1) Data

##### (1) Max. RPM

- Specifies the maximum speed of device which makes the rotate tag revolve fastest.
- XGT Panel divides the range from 0 up to the max. RPM value into 20 blocks and displays the rotation cycle while increasing by 20 ms per block.

## Chapter 6. Panel Editor

- (2) Signed: If selected, the rotation tag will rotate contrariwise when the value of the device is negative.

### 2) Graph

#### (1) Rotation Direction

- Specifies the Rotation Direction of the tag when the value of the device is positive.
- If the Rotation Direction is set clockwise and Signed available, it will turn clockwise when the value of the device is positive and counterclockwise when the value of the device is negative.

#### (2) Number of Images

- Specifies the Number of Images which are used to display the rotation tag.
- Available range of number is 2 ~ 8.
- Based on the Number of Images specified, each image will be displayed on the Property window. And each image can be changed as requested by the user. See 6.3 for details on Edit Image.

### 3) Application Example of Rotation Tag

- (1) For an application example, the property of the Rotation Tag is specified as shown below.

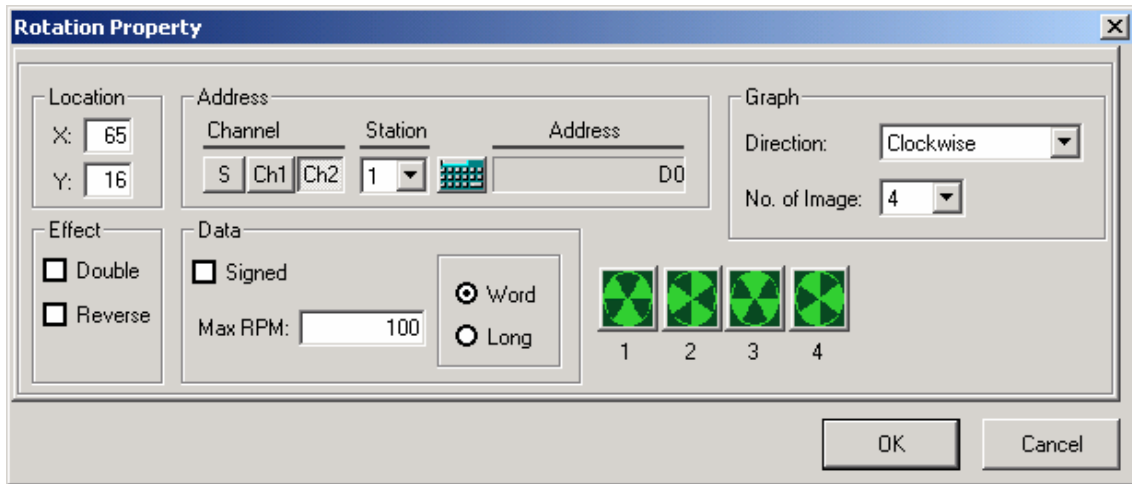

- (2) Since the Max. RPM is specified 100, the size of each block will be  $100/20 = 5$ .

- (3) Time taken for the Rotation Tag to rotate once according to the value of the device D0 of Station No. 1 is as follows.

Data Value	Block No.	Display Cycle	Time Taken per Round ( (Display Cycle) × (No. of Images) )
5 or less	20	400 ms	$400\text{ms} \times 4 = 1600\text{ms}$
6 - 10	19	380 ms	$380\text{ms} \times 4 = 1520\text{ms}$



## Chapter 6. Panel Editor

Data Value	Block No.	Display Cycle	Time Taken per Round ( (Display Cycle) × (No. of Images) )
91 ~ 95	2	40 ms	40ms × 4 = 160ms
96 or more	1	20 ms	20ms × 4 = 80ms

### 6.9.9 Move Tag ( )

Varies a position of tag according to the values of devices.

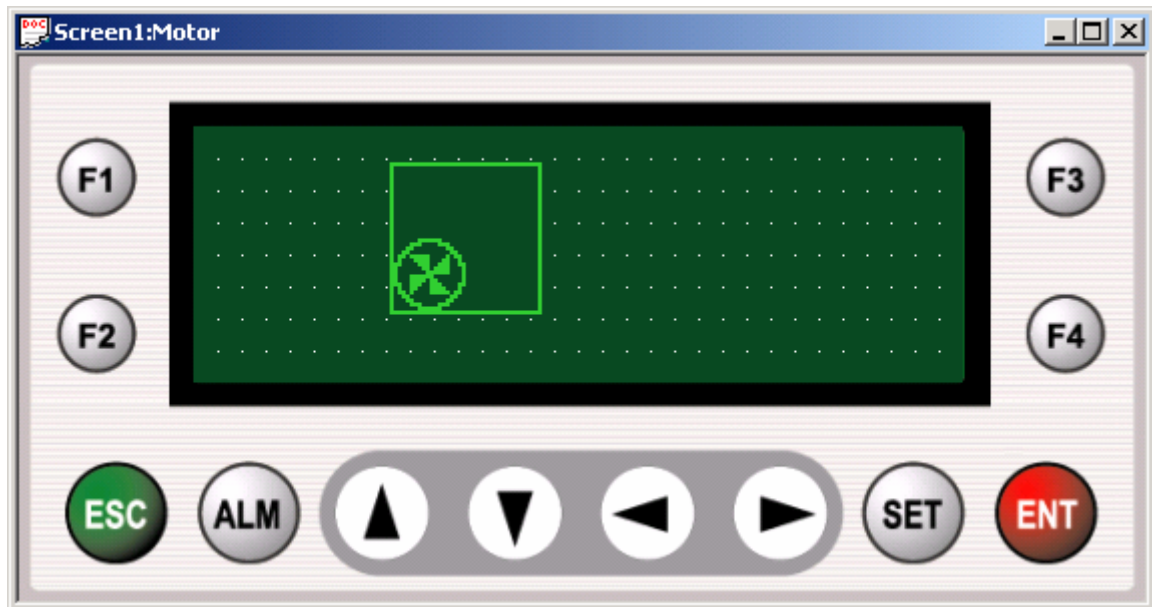

In order to specify the property of the Tag, double-click to display the Property setting window as shown below.

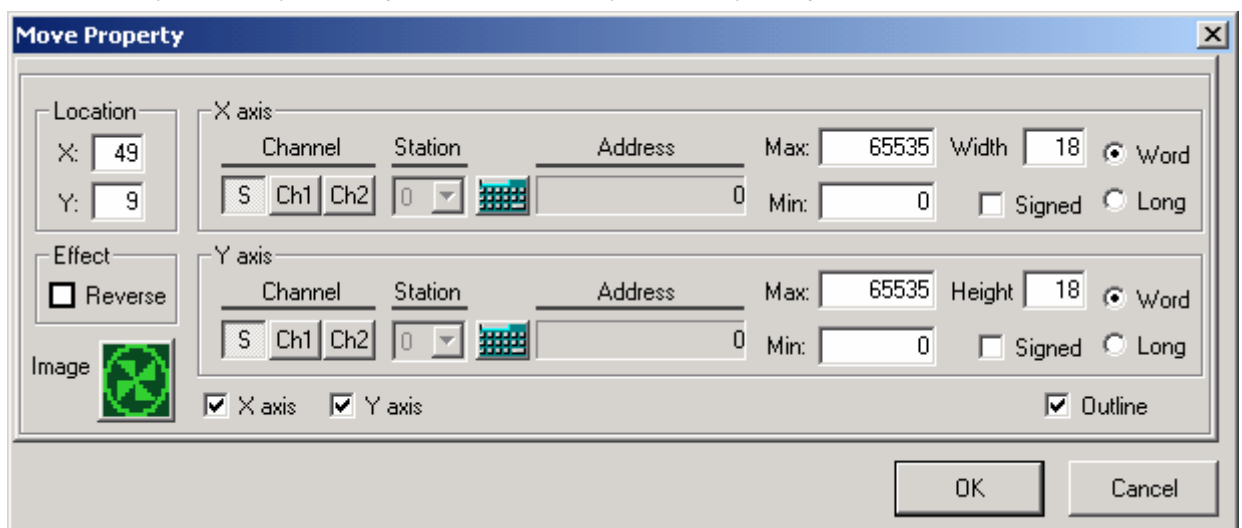

The Location, Effect, Addresses of X-axis Y-axis, Max., Min., Width and Height in the Move Property should be set identical to '6.9.5 Bar Graph Tag'.

## Chapter 6. Panel Editor

### 1) X-axis/Y-axis

- (1) Enables or disables X-axis and Y-axis.
- (2) If just one is selected between X and Y, linear movement will be allowed to the selected direction. And if all of the two axes selected, plane movement will be allowed. At least one of them has to be enabled.

### 2) Select Image

- (1) Allows the image used in Move Tag to be edited and added as requested by the user.
- (2) See 6.3 for details on Edit Image and Add Image.

### 2) Application Example of Move Tag

For an application example, the property of the Move Tag is specified as shown below.

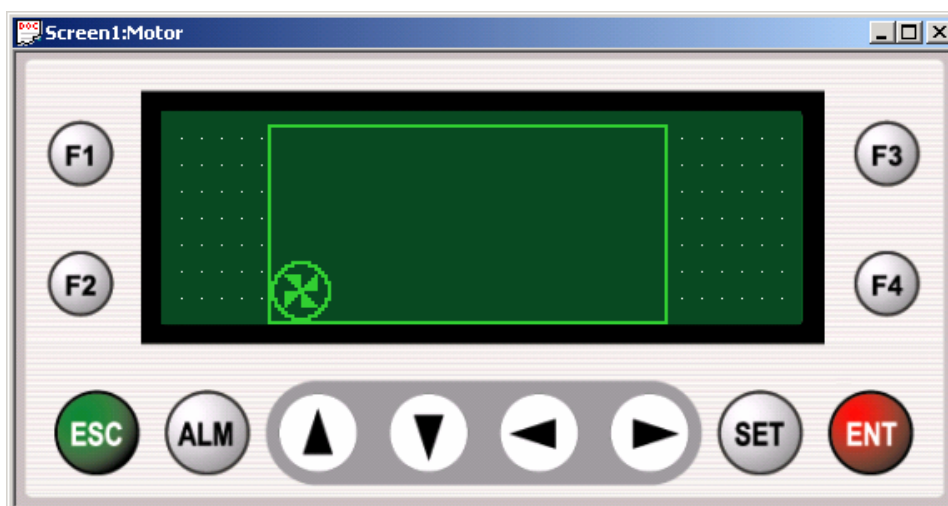
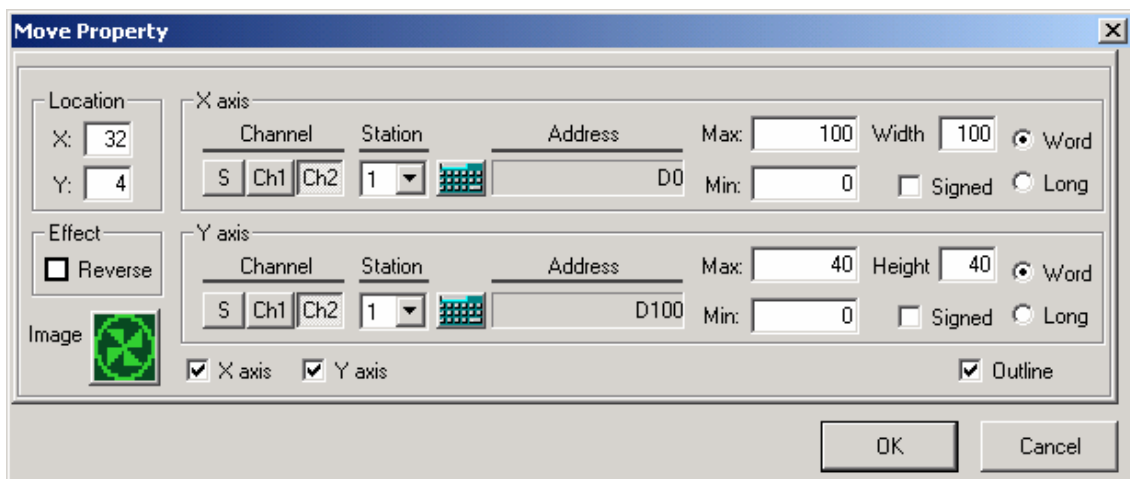

## Chapter 6. Panel Editor

(1) Width Move Unit:  $\text{Max.} / \text{Width} = 100 / 100 = 1$

(2) Height Move Unit:  $\text{Max.} / \text{Height} = 40 / 40 = 1$

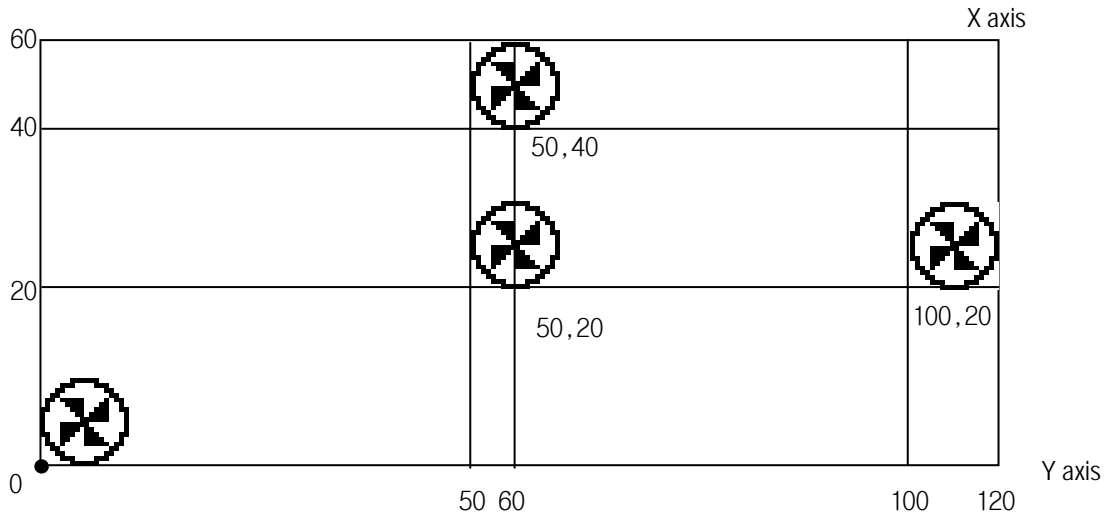

(3) Based on the value of the device specified on the X and Y axes, the Move Tag will be displayed.

### 6.9.10 Clock Tag ( )

Displays current time. (Available on XP10BKB/DC only)

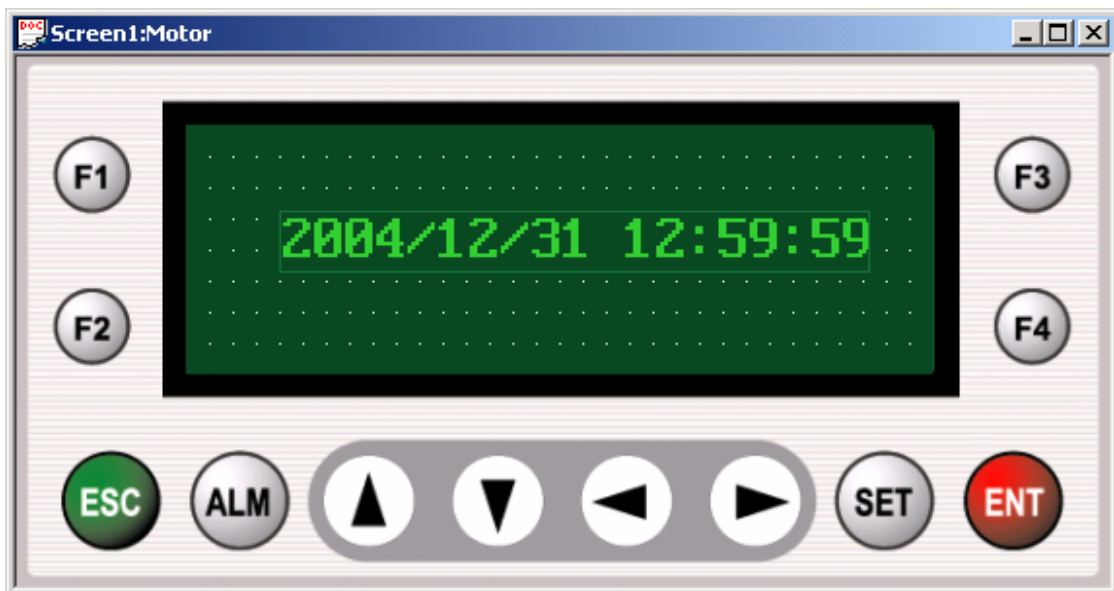

## Chapter 6. Panel Editor

In order to specify the property of the Tag, double-click to display the Property setting window as shown below.

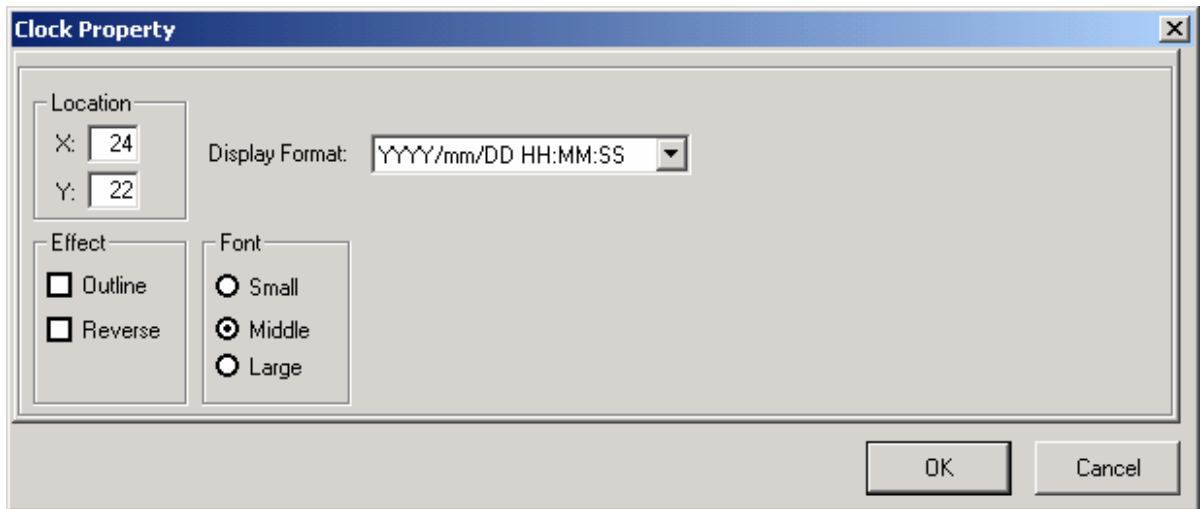

The Location, Effect and Font in the Clock Property should be set identical to '6.9.1 Numeric Tag'

### 1) Display

(1) Specifies a display format of a clock tag.

(2) Display Formats available are as shown in the table below.

No.	Display Format	Description	Example
1	YYYY/mm/DD HH : MM:SS	Year/month/date hour : minute : second	2004/06/03 10:12:24
2	HH : MM : SS	Hour : minute : second	10:12:24
3	YYYY/mm/DD	Year/month/date	2004/06/03
4	HH : MM	Hour : minute	10:12
5	mm/DD	Month/day	06/03
6	DD/mm/YYYY	Date/month/year	03/06/2004
7	DD/mm	Date/month	03/06
8	YYYY	Year	2004
9	mm	Month	06
10	DD	Date	03
11	HH	Hour	10
12	MM	Minute	12
13	SS	Second	24
14	WWW	Day of the week	Wed

### 6.10 Draw Menu

Shows the various functions of the Draw menu.

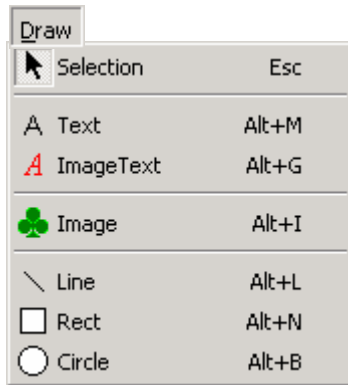

#### 6.10.1 Selection

It is a tag Selection mode, which is used to edit or select the tags registered on the screen.

#### 6.10.2 Text ( )

Displays the Text input by the user.

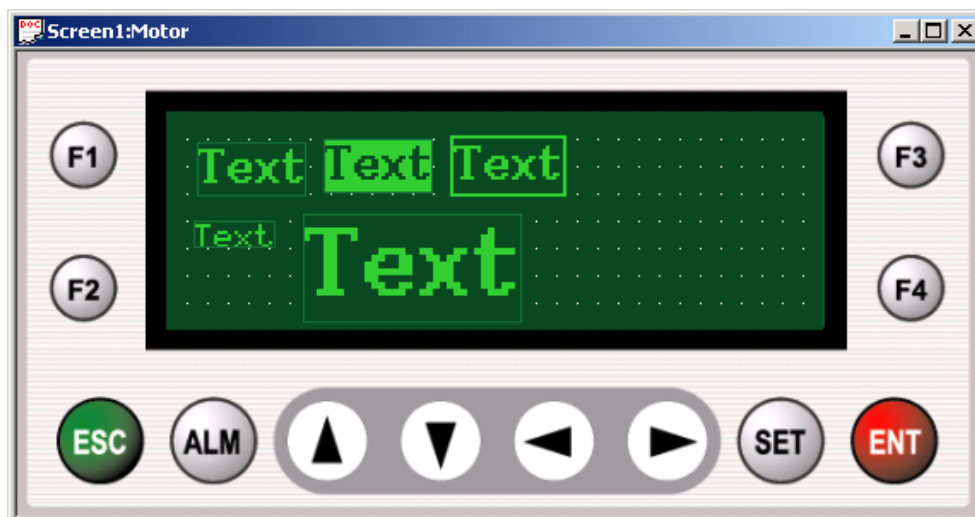

## Chapter 6. Panel Editor

In order to specify the property of the Text, double-click to display the Property setting window as shown below.

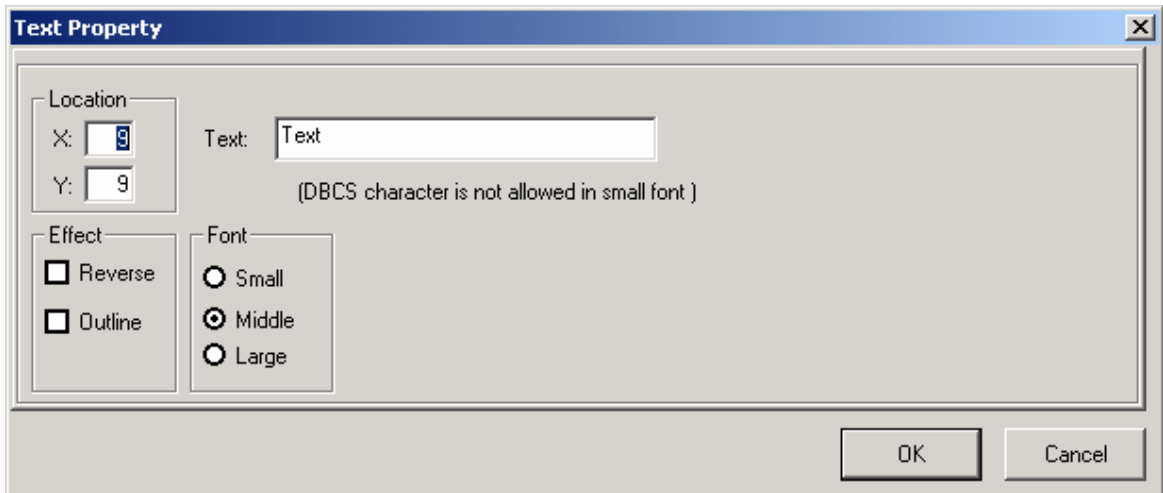

The Location, Effect and Font in the Text Property should be set identical to '6.9.1 Numeric Tag'

### 1) Text

- (1) Input the Text to be displayed.
- (2) Up to 24 English characters and 12 Korean characters available.

### 6.10.3 Image Text ( )

Displays the Text input by the user in an image, which allows diverse drawings with various fonts and texts presented.

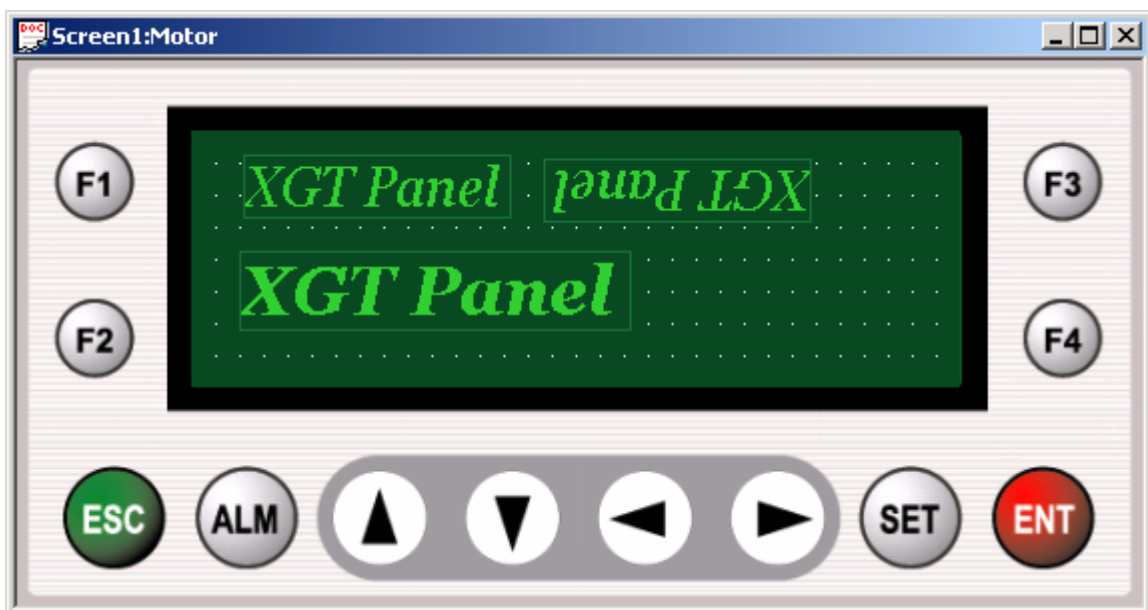

## Chapter 6. Panel Editor

In order to specify the property of the Image Text, double-click to display the Property setting window as shown below.

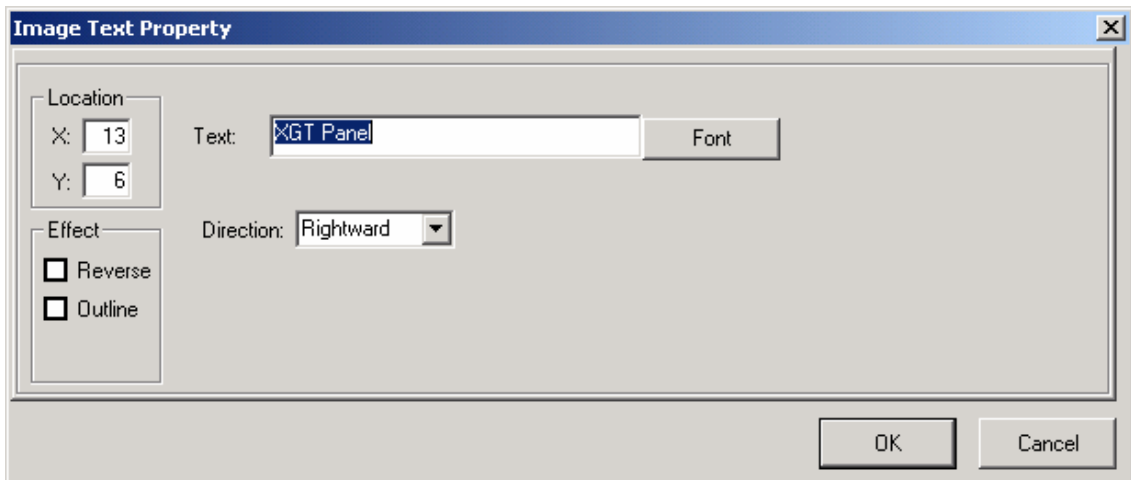

The Location and Effect in the Image Text Property should be set identical to '6.9.1 Numeric Tag'

### 1) Text

- (1) Input the Text to be displayed.
- (2) Up to 24 English characters and 12 Korean characters available.

### 2) Display Direction

- (1) Specifies the Display Direction of the Image Text.
- (2) One direction can be specified among Upward/Downward/Leftward/Rightward

### 3) Select Font

- (1) Specifies Font and Size of the Image Text.
- (2) If the Font selection button is pressed, a Font setting window will appear as below.

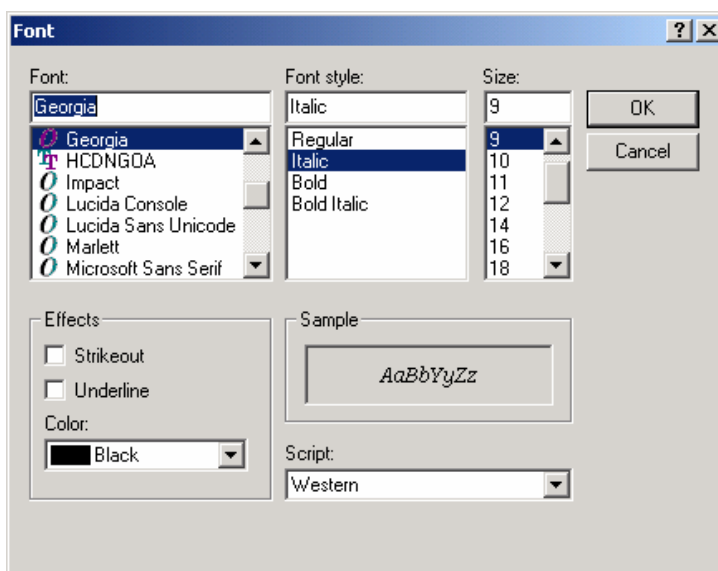

- (3) Specify Font, Font Style, Size and Effects and click OK to complete setting.

### 6.10.4 Image ( )

Displays a bitmap image.

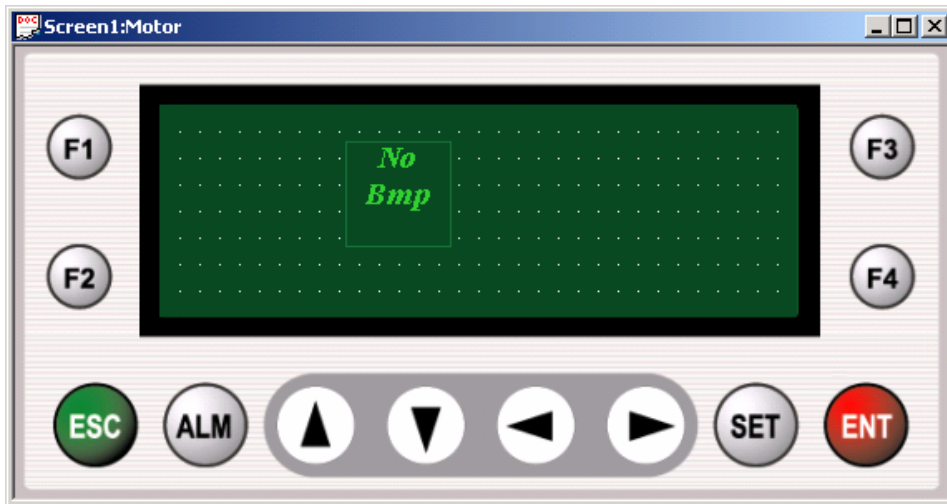

In order to specify the property of the Image Tag, double-click to display the Property setting window as shown below.

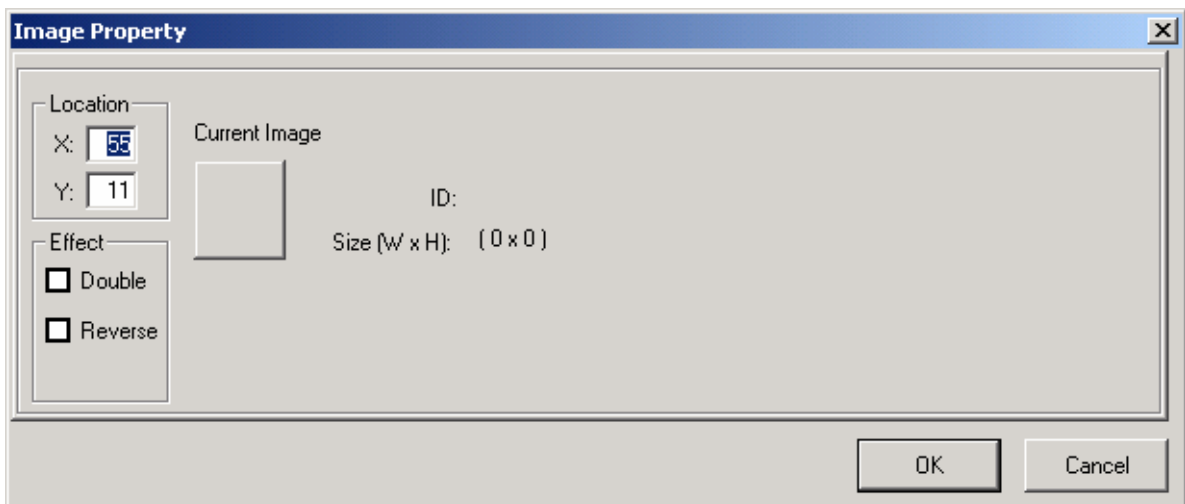

The Location and Effect in the Image Property should be set identical to '6.9.1 Numeric Tag'.

#### 1) Edit Image

- (1) Allows the displayed image to be changed or added as requested by the user.
- (2) See 6.3 for details on Edit Image and Add Image.
- (3) However, the size of the image should not exceed 192\*64 dots.



### 6.10.5 Line ( )

Draws a line of various shapes.

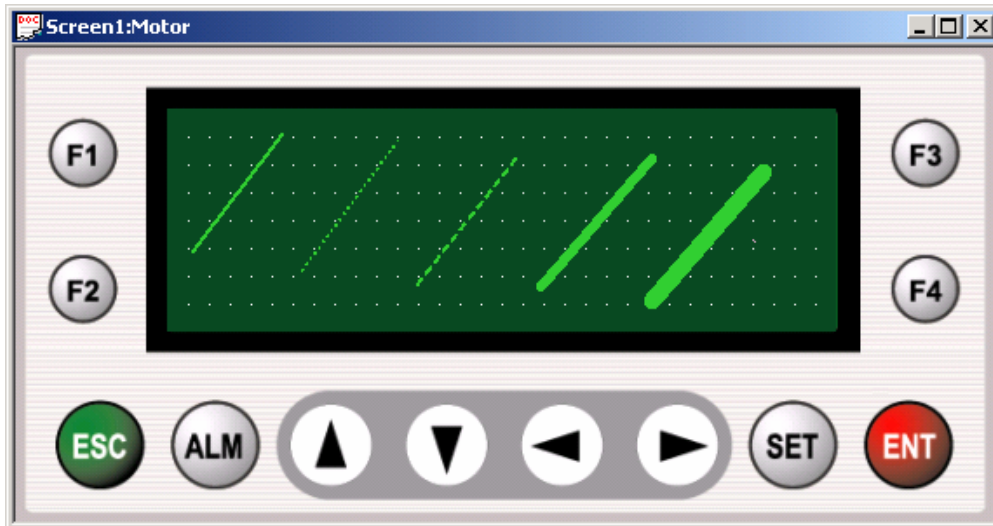

In order to specify the property of the Line Tag, double-click to display the Property setting window as shown below.

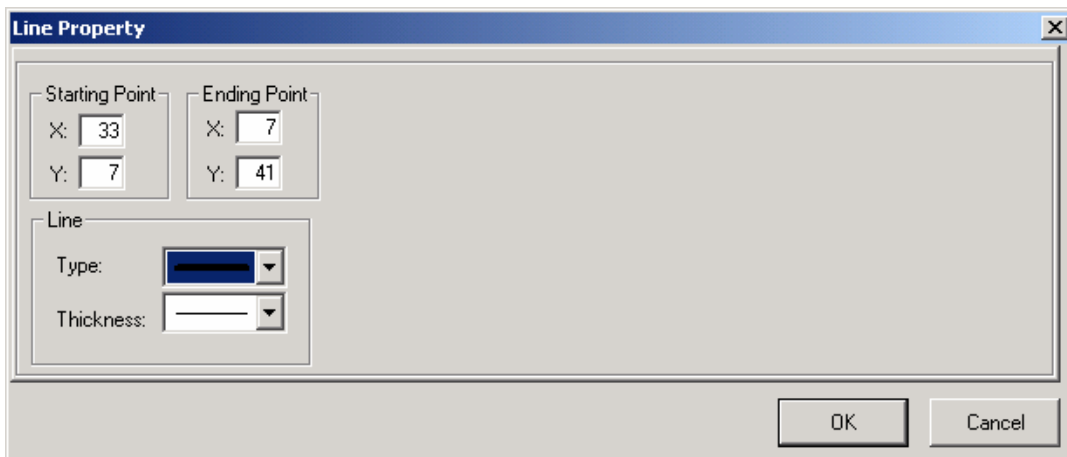

#### 1) Starting Point

- (1) Specifies X-Y coordinates of the starting point. (Max. X-axis: 0~191, Y-axis: 0~63)
- (2) Relocating is available by dragging the mouse.

#### 2) Ending Point

- (1) Specifies X-Y coordinates of the ending point. (Max X-axis: 0~191, Y-axis: 0~63)
- (2) Relocating is available by dragging the mouse.

## Chapter 6. Panel Editor

### 3) Line

- (1) Kind : Specifies a type of line. (One of solid line, dotted line, dashed line)
- (2) Thickness: Specifies thickness of line. (From 1 to 5 dots)

### 6.10.6 Rect ( )

Draws a rectangle of various shapes.

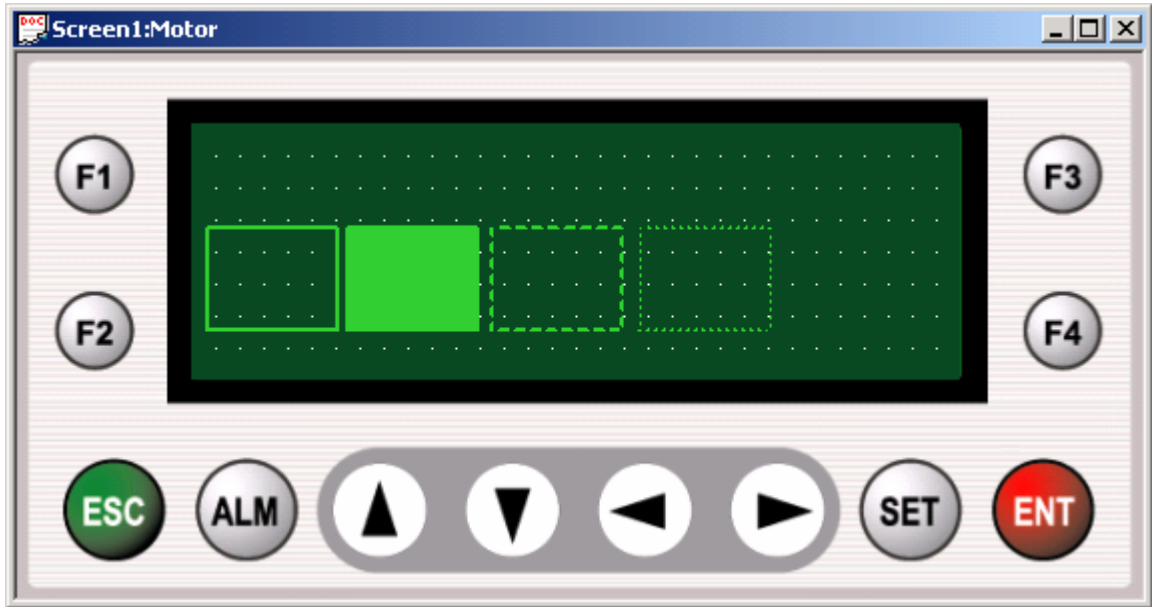

In order to specify the property of the Rectangle Tag, double-click to display the Property setting window as shown below.

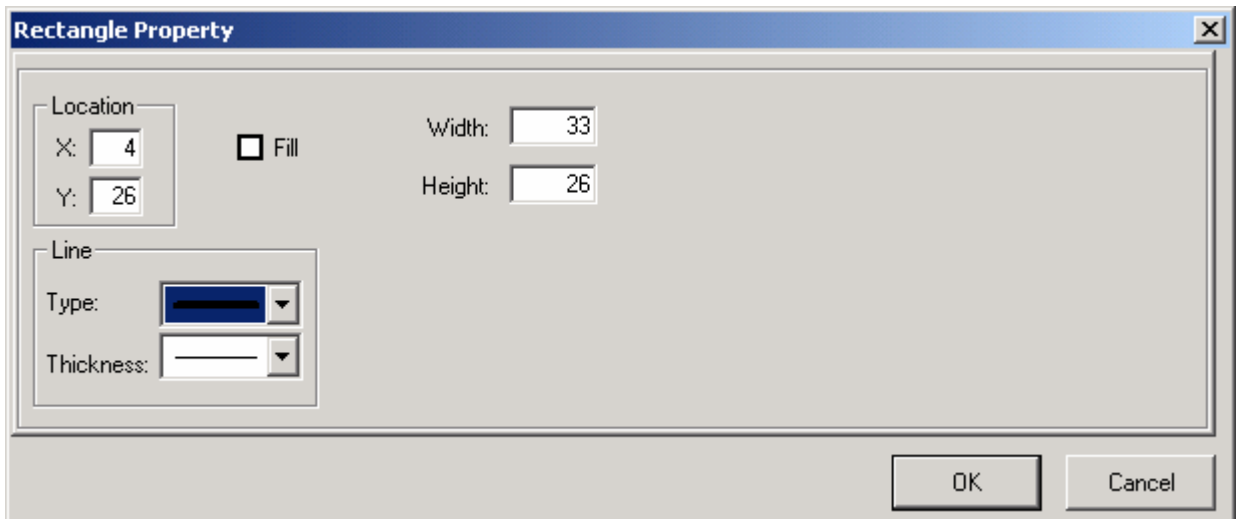

### 1) Location

- (1) Indicates tag's location (X-axis:0~191, Y-axis:0~63)
- (2) Thereupon, the X,Y coordinates point at the left upper edge of the tag.

## Chapter 6. Panel Editor

---

### 2) Line

See '6.10.5 Line Tag'.

### 3) Fill

Fills the inside of the rectangle.

### 4) Width, Height

Specifies width and height of the rectangle.

## 6.10.7 Circle ( )

Draws a circle of various shapes.

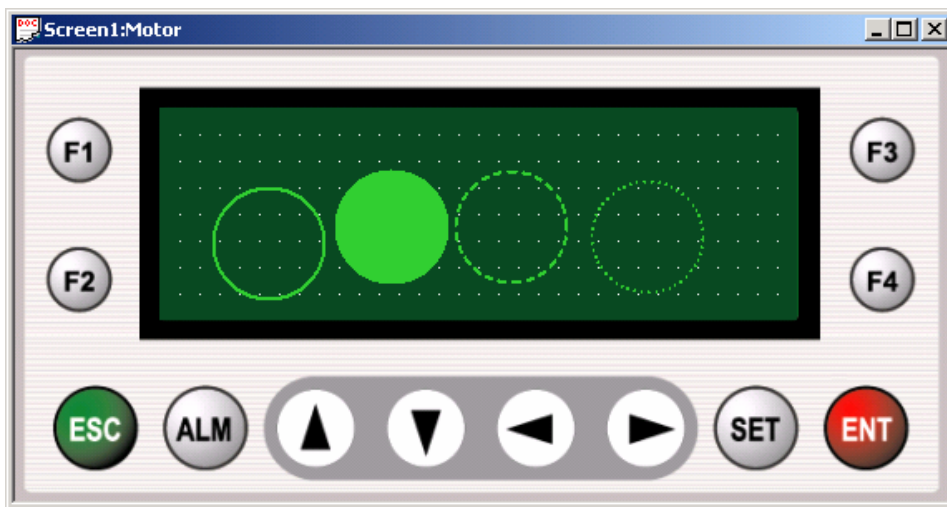

In order to specify the property of the Circle Tag, double-click to display the Circle Property setting window as shown below.

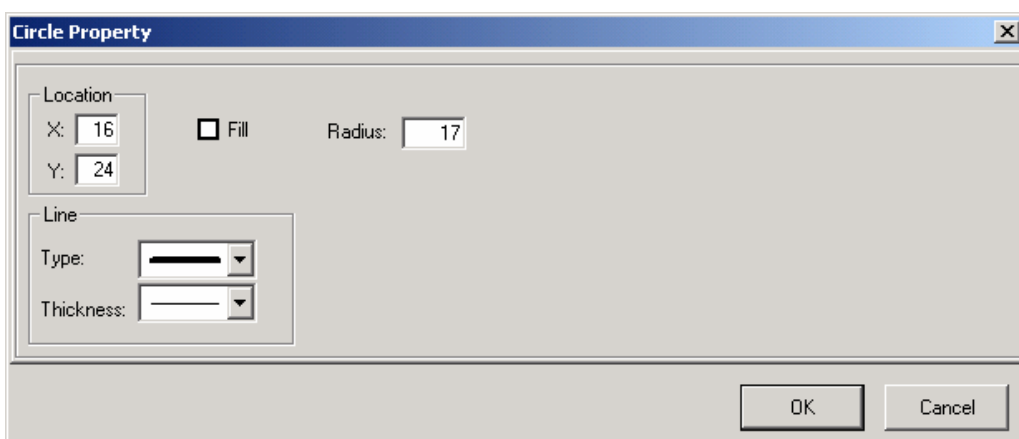

See '6.10.6 Rectangle Tag' for details on Location, Line and Fill.

### 1) Radius

Specifies a radius of the circle.

### 6.11 Common Resource Menu

The following explains about the common resource of the XGT Panel.

Common Resource	
Message	Ctrl+M
Image	Ctrl+B
Parameter	Ctrl+E
Alarm	Ctrl+W
Calculation	Ctrl+I
Block Communication	Ctrl+T
Reservation	Ctrl+R

#### 6.11.1 Message

- . Manages the message contents of a message tag.
- . Controls general management of Add, Edit and Delete for the message tag-related text.
- . Refer to '6.9.2 Message Tag' for details on Message Add, Edit and Delete.

#### 6.11.2 Image

- . Shows the individual information and the list of the images presently used in the project.
- . Select View Image to display the View Image window as shown below.

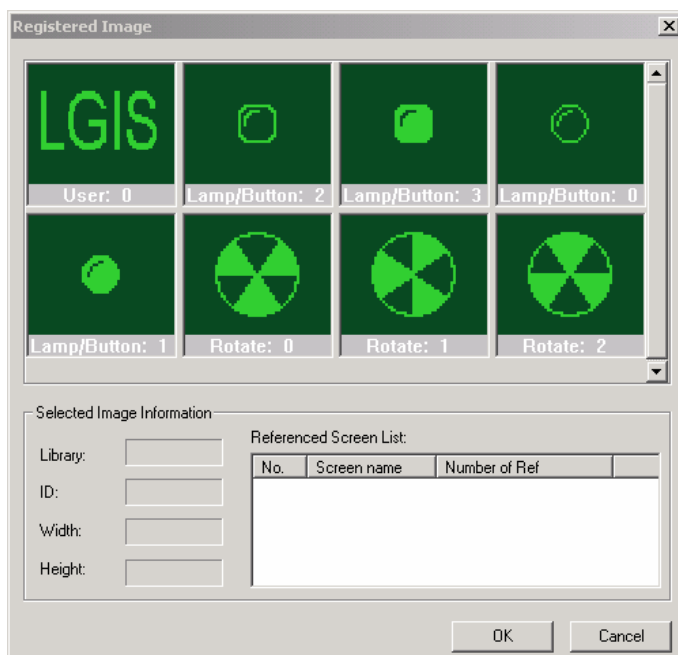

### 6.11.3 Parameter

Specifies various parameters of Panel Editor.

The screenshot shows the 'Parameter' dialog box with the following settings:

- Initial Screen: 0
- Language: English
- Backlight Off
- Wait Time: 20 Min
- Screen Saver
- Wait Time: 0 Min
- Change Screen: 0
- Latch
- Start Addr: 0
- End Addr: 0
- Online Screen Change (HMI <- PLC)
- Channel: S, Station: Ch1, Ch2, Address: 0
- Send Current Screen No. (HMI -> PLC)
- Channel: S, Station: Ch1, Ch2, Address: 0

#### 1) Initial Screen

- (1) Specifies a screen to display if XGT Panel is turned on.
- (2) If the initial screen is not specified, XGT Panel displays a screen which has the lowest ID

#### 2) Backlight Off

- (1) Turns the backlight off if there is not a key input during specified time. (0 ~ 65535minutes)
- (2) If any key is pushed when the backlight is in the off state, the backlight is turned on again.

#### 3) Screen Saver

Changes current screen to the specified screen if there is not a key input during specified time.

## Chapter 6. Panel Editor

---

### 4) Latch

- (1) Specifies the latch area of XGT Panel's system memory.
- (2) The data of latch area are retained when power is turned off (B type only)

### 5) Online Screen Change

- (1) Changes a current screen according to the value of device.
- (2) Refer to Ch. 6.7.2 Digit Tag for details about specifying address.

### 6) Send Current Screen No.

- (1) Sends a number of current screens to PLC.
- (2) Refer to Ch. 6.7.2 Digit Tag for details about specifying address.

### 7) Language

- (1) Specifies the language displayed on the XGT Panel menu.
- (2) One of the languages among Korean, English and Chinese is available.
- (3) If Korean or Chinese has been selected, its applicable font should be downloaded on the XGT Panel for normal display.
- (4) See '6.12 Communication' for details on Font Download.

## 6.11.4 Alarm

- . Specifies various properties about the alarm function.
- . Displays registered alarm messages and operates a buzzer when a specified activating condition occurs.

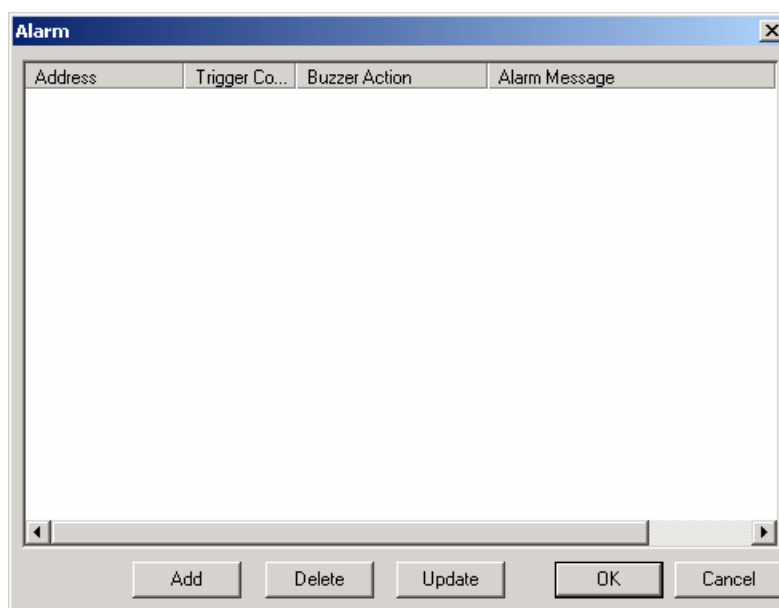

- . Click the Add button to set an alarm.

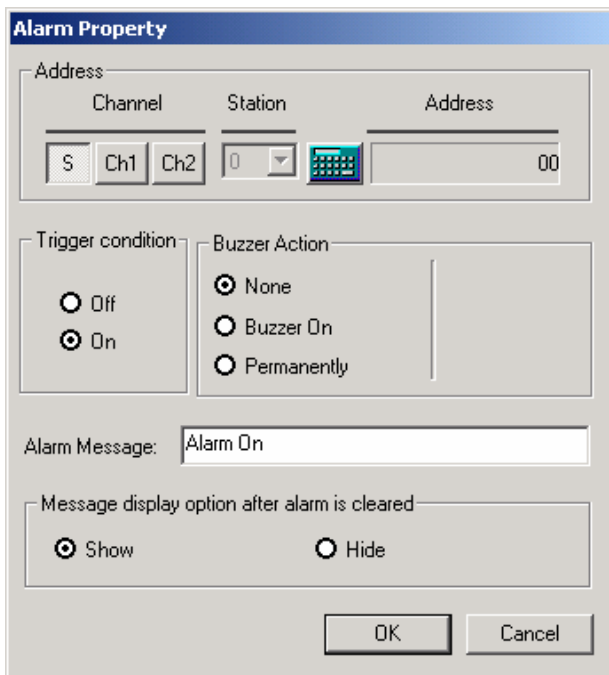

1) Address

- (1) Specifies the address of a device (Bit device).
- (2) Refer to the section '6.9.3 Button Tag' for details to set the address.

2) Trigger condition

- (1) Off: Operates at the rising edge of a value of device.
- (2) On: Operates at the falling edge of a value of device.

3) Buzzer Action

Item	Description
None	Buzzer does not operate.
Buzzer On	Buzzer operates during specified time. (The buzzer stops if ESC/ALM key is pushed while it operates.)
Permanently	Buzzer operates until ESC/ALM key is pushed

4) Alarm Message

Max. size of content: Up to 37 letters.

5) Message display option after alarm is cleared

- (1) If the alarm condition is removed, it specifies the message display option.

### 6.11.5 Calculation

Specifies a calculation function.

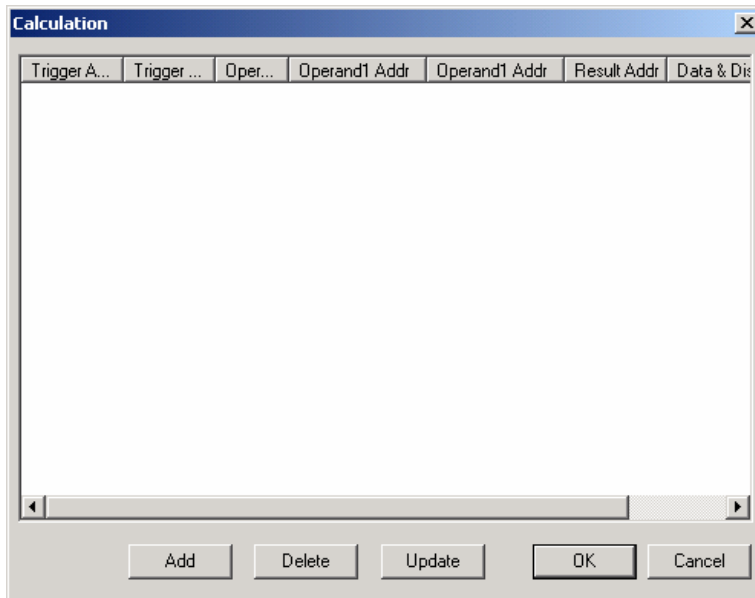

Click the Add button to register a calculation function.

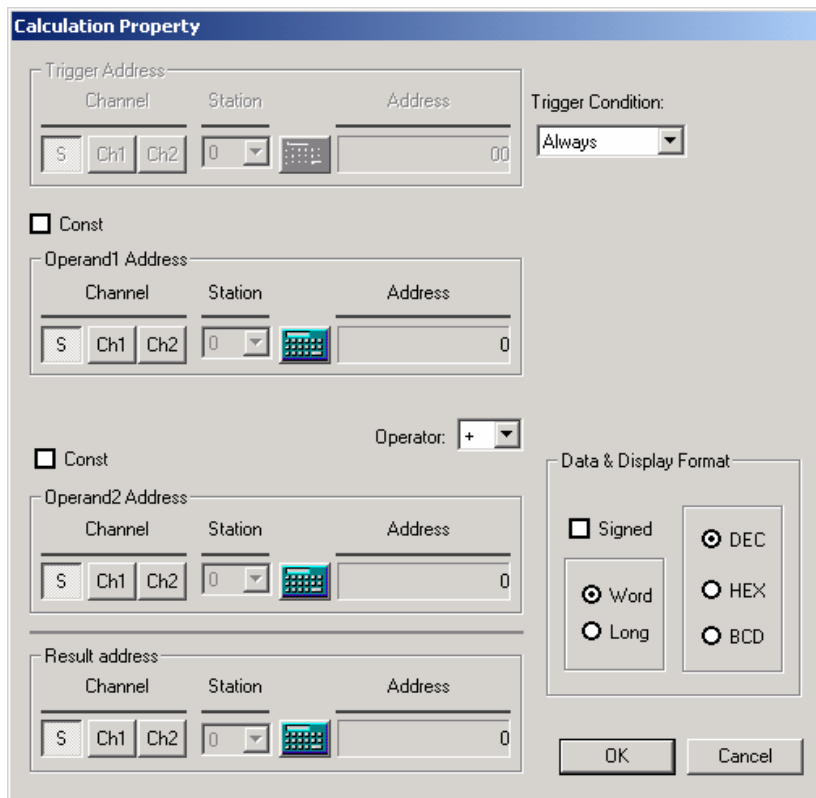



## Chapter 6. Panel Editor

---

### 1) Trigger Condition

Specifies an activating condition of calculation function.

Condition	Description
Always	Operates at every scan.
On	Operates once at the rising edge of trigger device
Off	Operates once at the falling edge of trigger device
Toggle	Operates at the rising and falling edge of trigger device
During On	Operates at every scan during the trigger condition is On
During Off	Operates at every scan during the trigger condition is Off

### 2) Trigger Address

(1) Specifies the address of trigger device (Bit device).

(2) Refer to the section 6.9.3 Button Tag for details to specify the address.

### 3) Operand Address

(1) Specifies the address of the device used in calculation and the address of the device where calculation results are to be saved.

(2) If Constant is selected, the address window will disappear and a constant can be specified.



The image shows a configuration window for the Operand Address. At the top left, there is a checked checkbox labeled 'Const'. Below this, there is a text input field containing the number '0'.

(3) See '6.9.1 Numeric Tag' for details on Setting Address.

### 4) Operator

(1) Specifies an operator.

(2) Operators available are as follows.

Operator	Description
+	Adds operand 2 to operand 1.
-	Subtracts operand 2 from operand 1.
x	Multiplies operand 2 with operand 1.
/	Divides operand 1 by operand 2.

## Chapter 6. Panel Editor

Operator	Description	
%	Gets the remainder when operand 1 is divided by operand 2	
&	Compares each bit of operand 1 to the corresponding bit of the operand 2. If both are 1, the corresponding bit of result device is set to 1. Otherwise it is set to 0.	
	Compares each bit of operand 1 to the corresponding bit of the operand 2. If either bit is 1, the corresponding result bit is set to 1. Otherwise it is set to 0.	
^	Compares each bit of operand 1 to the corresponding bit of the operand 2. If one bit is 0 and the other bit is 1, the corresponding bit of result device is set to 1. Otherwise it is set to 0.	
<<, >>	Shifts the operand 1 left(<<) or right(>>) by the number of positions the operand 2 specifies.	
<	Compare the operand1 to the operand 2 to test the validity of the specified relationship.	Writes 1 to the result device if the tested relationship is true and writes 0 if it is false.
>		
==		

### 5) Data

(1) Specifies the data type.

### 6) Display Format

(1) DEC: Displays in decimal format.

(2) HEX: Displays in hexadecimal format.

(3) BCD: Displays in binary coded decimal format.

## 6.11.6 Block Communication

Specifies properties of Block Communication function.

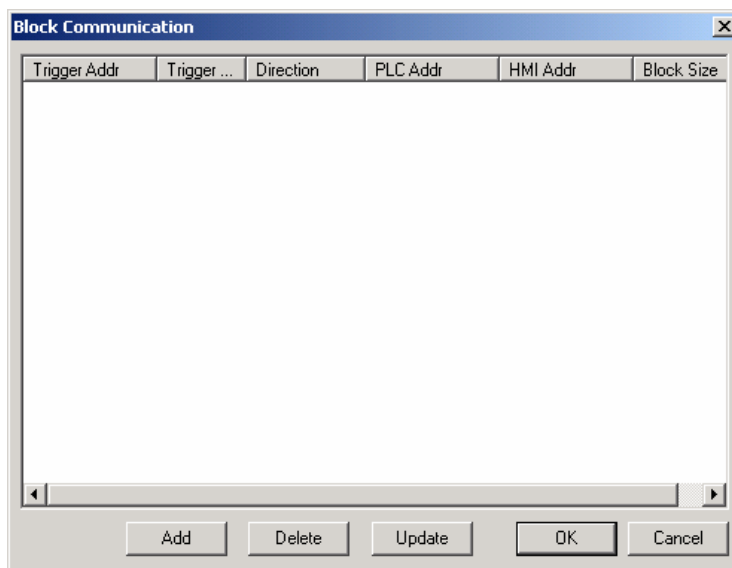

- Click the Add button to register a block communication function.

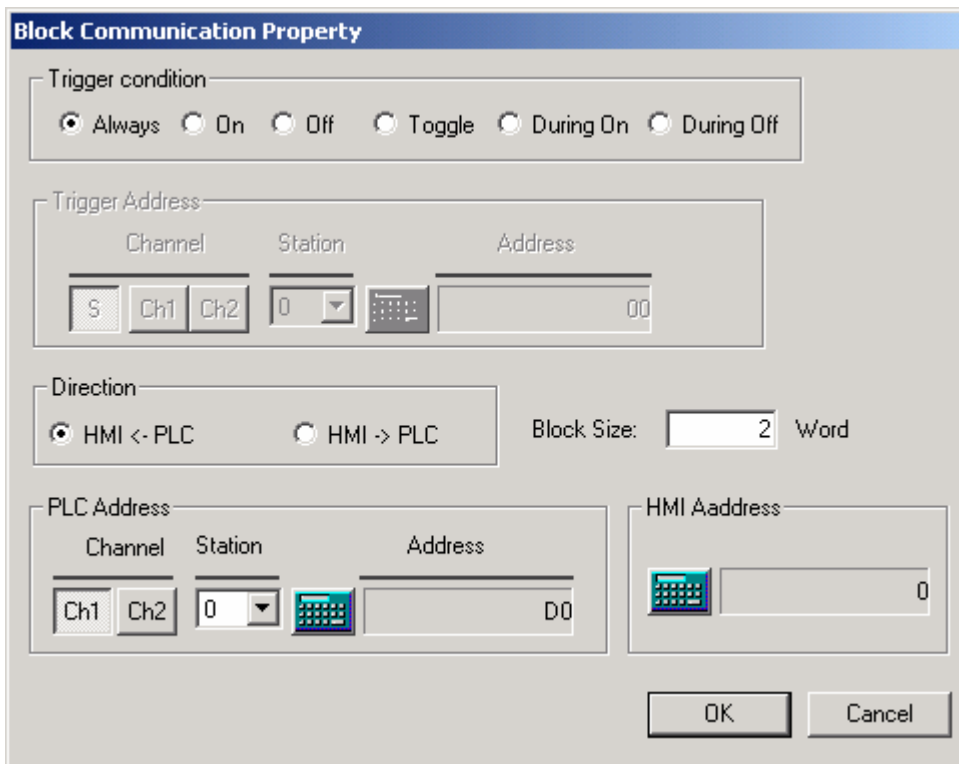

1) Trigger condition

Specifies the trigger condition of block communication.

Condition	Description
Always	Operates at every scan
On	Operates once at the rising edge of a trigger device
Off	Operates once at the falling edge of a trigger device
Toggle	Operates at the rising or falling edge of trigger device
During On	Operates at every scan during the trigger condition is On
During Off	Operates at every scan during the trigger condition is Off

2) Trigger Address

(1) Activated when the trigger condition is not 'Always', and it specifies the address of trigger device.

(2) Refer to the section '6.9.3 Button Tag' for details to specify the address.

3) Direction

(1) HMI <- PLC: Reads values of specified devices of PLC and writes them into the system memory of HMI.

(2) PLC <- HMI: Reads values of the system memory of HMI and writes them into specified devices of PLC.

## Chapter 6. Panel Editor

---

### 4) Data

Specifies a size of data to communicate (Max. 60Words).

### 5) PLC Address & HMI Address

(1) Specifies the addresses of PLC and system memory of HMI.

(2) Refer to ' 6.9.1 Numeric Tag' for details to specify the address.

## 6.11.7 Reservation

Makes a specific bit turned On or Off of the internal memory of the instrument or XGT Panel connected at the time reserved with the Reservation function.

Reservation function is available only at XP10BKB/DC.

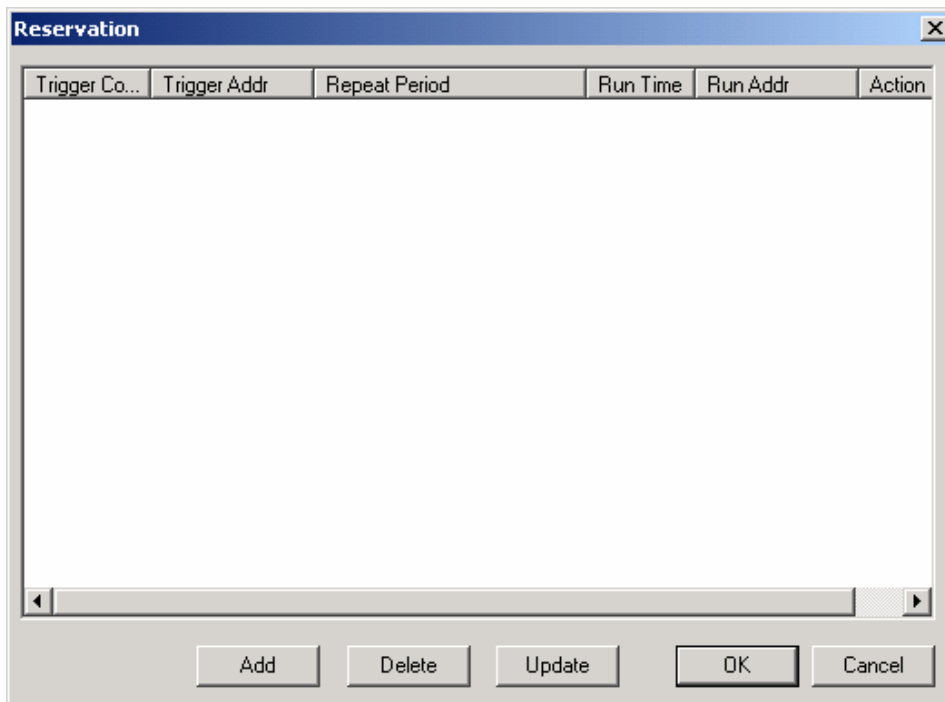

- Click the Add button to register a reservation function.

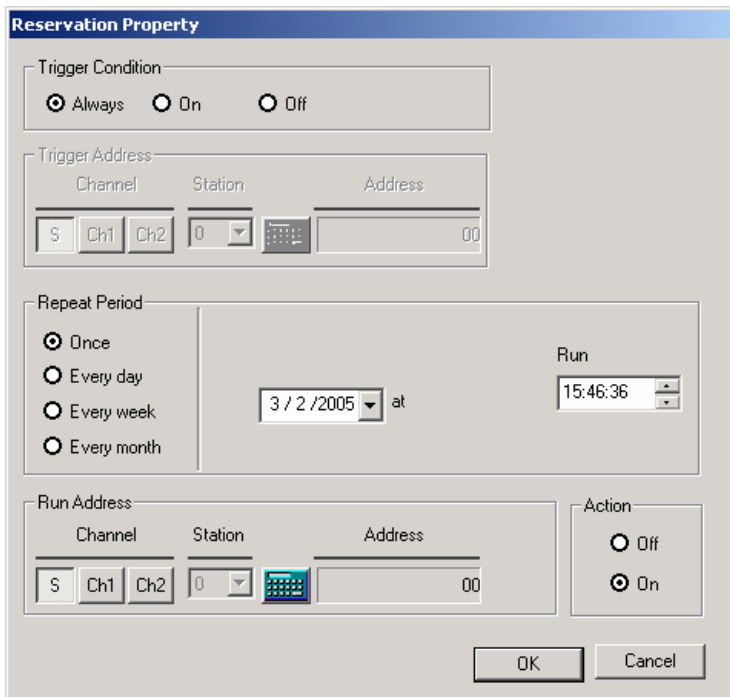

1) Trigger Condition

(1) Specifies an activating condition of the reservation function.

Condition	Description
Always	Operates always
On	Operates during the value of trigger device is On
Off	Operates during the value of trigger device is Off

2) Trigger Address

(1) Specifies the address of trigger device (Bit device).

(2) Refer to the section 6.9.3 Button Tag for details about specifying address.

3) Repeat Period

Item	Repeat Period
Once	Operates once to be reserved.
Every day (D)	Operates at the specified time of each day
Every week (W)	Operates at the specified time of day of the week.
Every month (M)	Operates at the specified time of the day of the month.

## Chapter 6. Panel Editor

---

### 4) Run Address and Action

- (1) Activated when the trigger condition is not 'Always', and it specifies the device's address to execute the block communication.
- (2) Refer to the section '6.9.3 Button Tag for details' to specify the address.

### 5) Setting Example

- (1) The following example represents that M000 device connected to Channel 1 is set On at 09:43:33 on the 1<sup>st</sup> day every month when No.0 bit of the internal memory S0 of XGT Panel is On.
- (2) Assume that reservation function is specified as shown above.
- (3) M0000 (Bit device) of PLC is turned on at 9:00:30 on the 1<sup>st</sup> day every month.

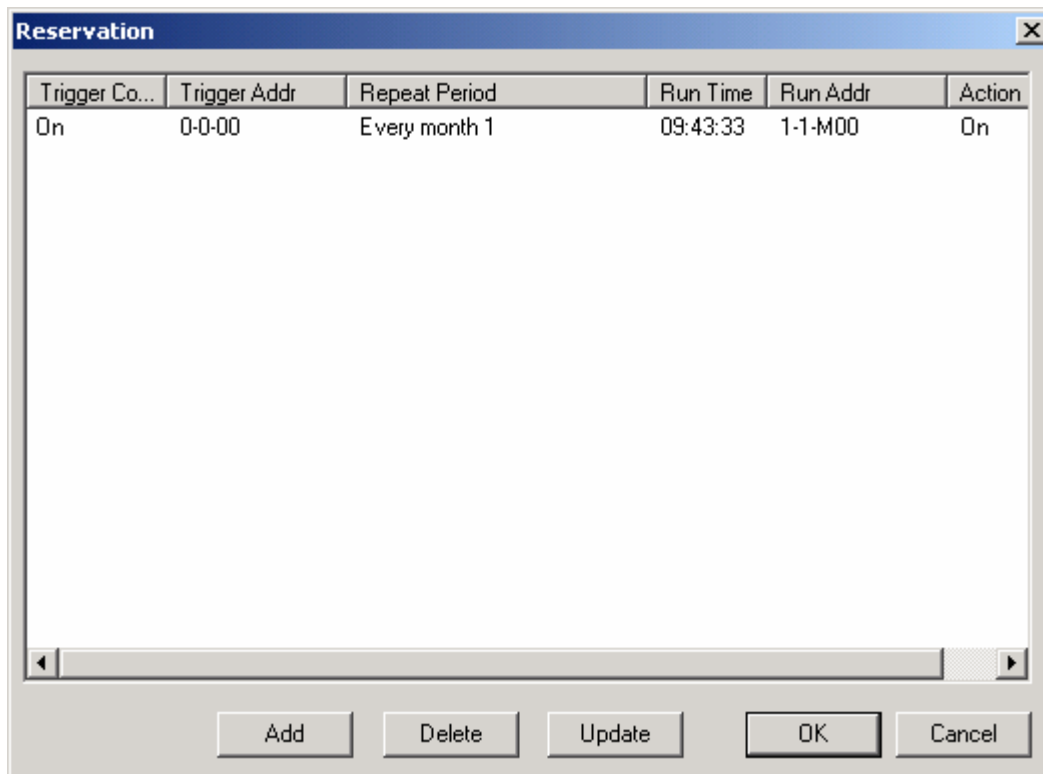

## 6.12 Communication Menu

The following explains about Communication menu.

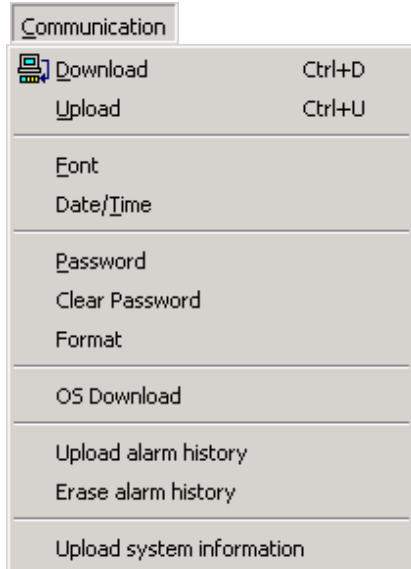

### 6.12.1 Download/Upload

Downloads/Uploads a created project at the XGT Panel.

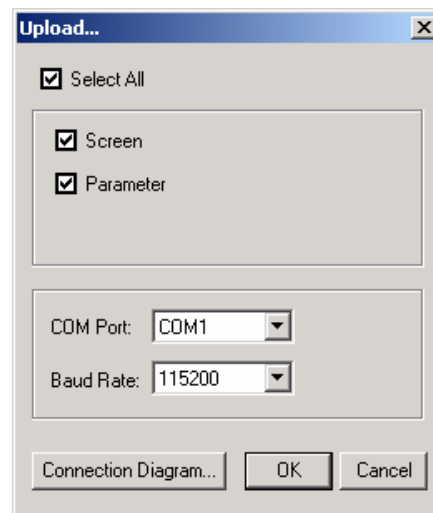
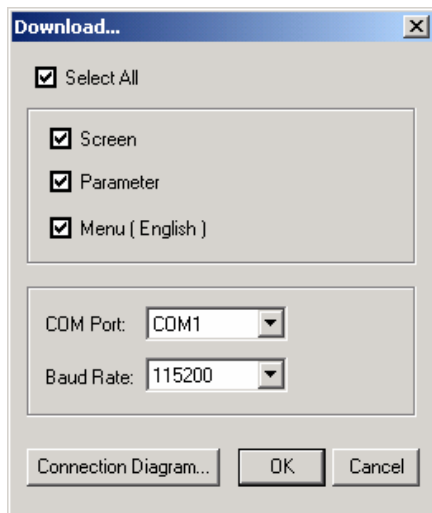

Downloads various files drawn from the Panel Editor to the XGT Panel or uploads from the XGT Panel to the Panel Editor.

Items	Description
Screen	Downloads/Uploads screens.
Parameter	Downloads/Uploads files related with Parameter, Alarm, Calculation, Block Communication and Reservation.
Menu	Downloads/Uploads text files related with the XGT Panel Menu and English Font.
Select all	Downloads/Uploads all.

### 6.12.2 Font

Downloads a specified font.

Other fonts than provided on the Panel Editor are unavailable to download.

Select Communication -> Fonts to display the window as shown below.

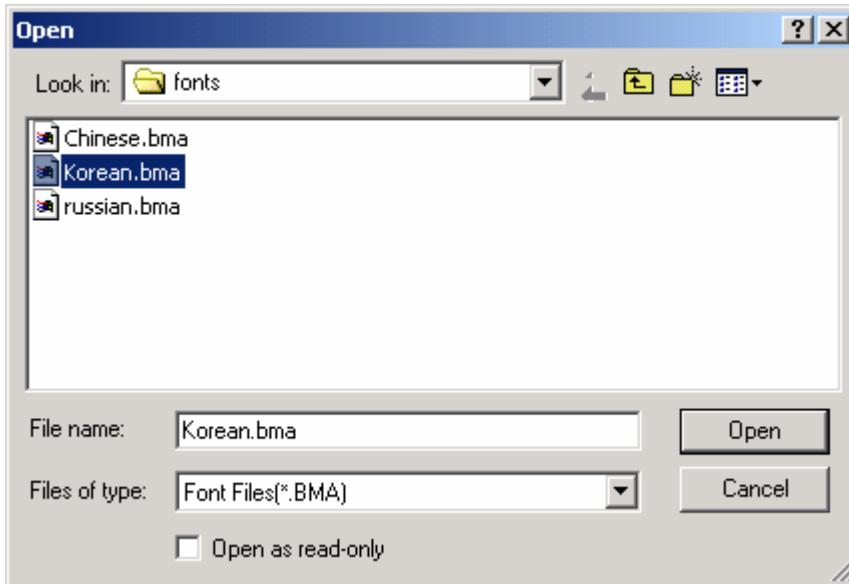

Select the Font to download and click Open to display the window as shown below.



Click 'Yes' to start Download.

### 6.12.3 Date/ Time

Specifies the Date/ Time of XGT Panel.

(Only available at XP10BKB/DC.)

It can be set with the time of the PC or the specified time.

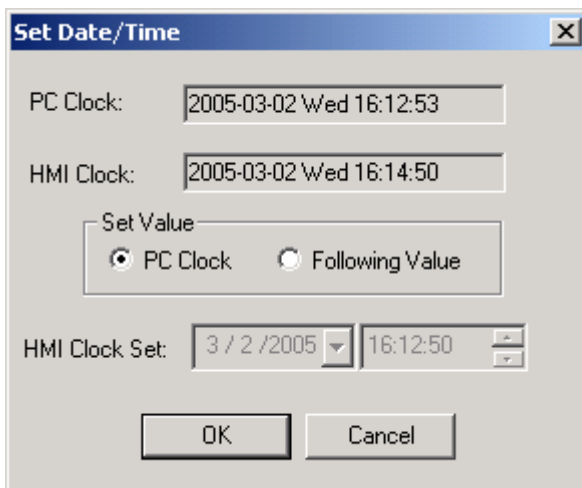



### 6.12.4 Password

Sets a download/upload password.  
Up to 10 alphanumeric characters are available.

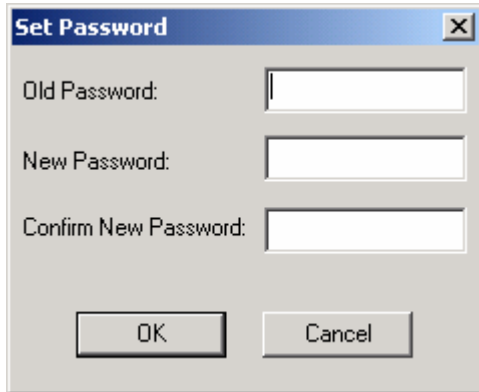

The 'Set Password' dialog box features a title bar with a close button (X). It contains three text input fields: 'Old Password:', 'New Password:', and 'Confirm New Password:'. At the bottom, there are two buttons: 'OK' and 'Cancel'.

If Password has been specified, Confirm Password window will be displayed as below to confirm download/upload. Correct password should be input to start download/upload.



The 'Confirm Password' dialog box features a title bar with a close button (X). It contains one text input field labeled 'Input Password:'. At the bottom, there are two buttons: 'OK' and 'Cancel'.

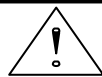

#### Warning

- ▶ You can't download but also can't upload project if you lose the password.
- ▶ Be careful not to lose when you set the password.

### 6.12.5 Clear Password

Cancels the Password previously set.  
When Clear Password is selected, Confirm Password window will be displayed as below only if any password has been specified.



The 'Confirm Password' dialog box features a title bar with a close button (X). It contains one text input field labeled 'Input Password:'. At the bottom, there are two buttons: 'OK' and 'Cancel'.

If the password presently specified is input, a message as below will be displayed to cancel the password.

### 6.12.6 Entire Memory Format

Erases the entire memory of the XGT Panel.

If password is lost so that download/upload is unavailable, use the Entire Memory Format which deletes the entire memory of the XGT Panel, then allowing its reuse.

However, be careful that recovery of the projects and memory of the XGT Panel is not possible if once erased.

Select Entire Memory Format to display the confirmation window as below.

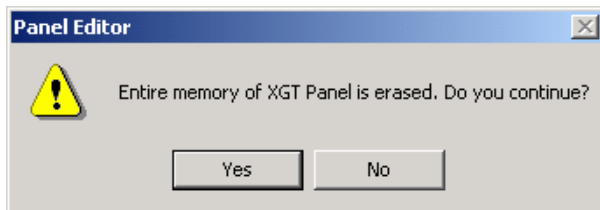

Click 'Yes' to delete the entire memory of the XGT Panel and a message will be displayed as below.

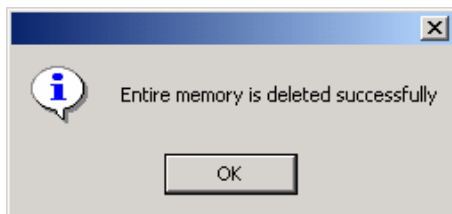

### Caution

- ▶ Be careful! All the projects of the XGT Panel will be deleted and unavailable to recover if once Entire Memory Format is executed.

### 6.12.7 O/S Download

Executes the program which is able to download the XGT Panel O/S.

Allows O/S to be downloaded conveniently when O/S needs update.

If O/S download selected, O/S download program will be executed as follow.

## Chapter 6. Panel Editor

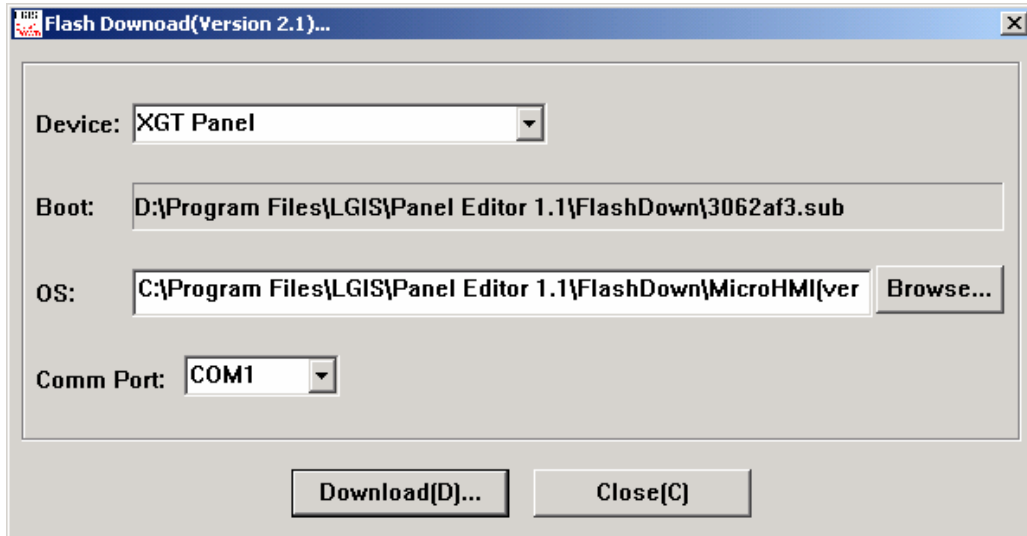

- (1) Set Device to be the XGT Panel.
- (2) Set O/S to be the XGT Panel O/S that the extension is \*.MOT.
- (3) Set Comm port (Communication Port) and click Download(D) to start to download the XGT Panel O/S.
- (4) At this moment, let the Dip Switches (used to download XGT Panel O/S) all set to O/S as shown below.

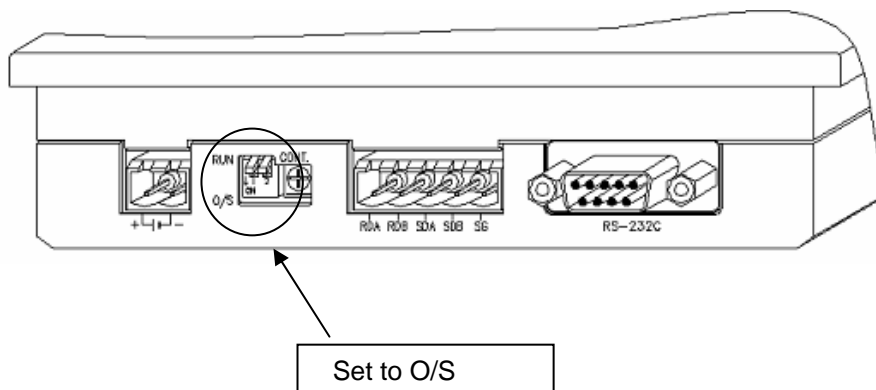

- (5) If download is completed, change all the O/S Download Dip Switches to RUN while the power of the XGT Panel is turned off. Then, supply the power again to start the normal operation of the XGT Panel.



### Caution

- ▶ If incorrect O/S is downloaded, normal operation of the XGT Panel may not be allowed. Be sure not to execute O/S Download if not inevitably necessary.

### 6.12.8 Read Alarm History

Reads Alarm History saved on the XGT Panel.

Efficient management of the Alarm History is available since the read Alarm History can be saved and specific alarms can be searched for or deleted.

Select Read Alarm History to display the window as below.

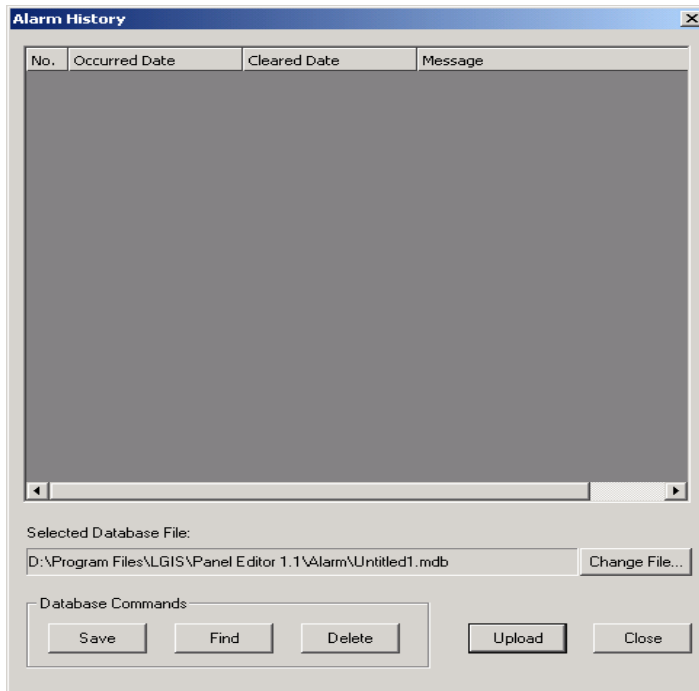

#### 1) Upload

(1) Reads all Alarm History saved on the XGT Panel to display in the sequence of occurrence time as shown below.

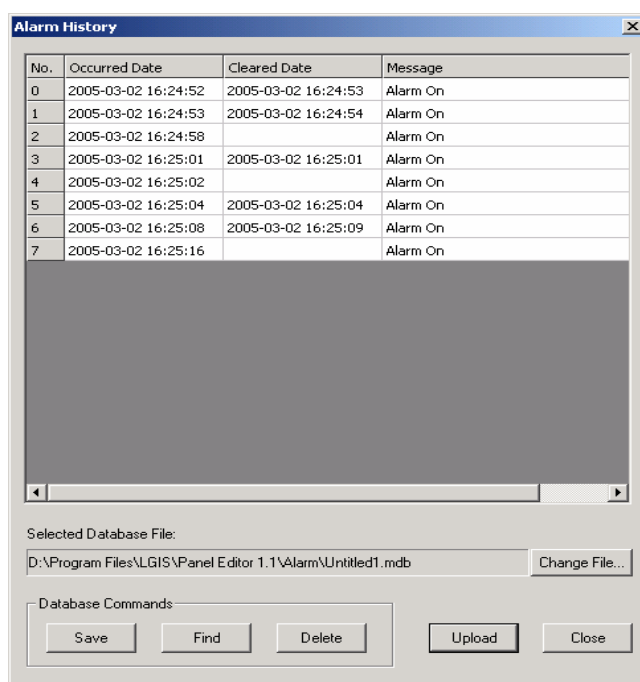

## Chapter 6. Panel Editor

---

### 2) Save

- (1) Press 'Save' to save the read Alarm History in the file.
- (2) Press 'Change File' and input a desired file name to change the file name to be saved. Then click Save to save the file name as requested.

### 3) Find

- (1) Searches the entire alarm history for specific information.
- (2) Press 'Find' to display the window as below.

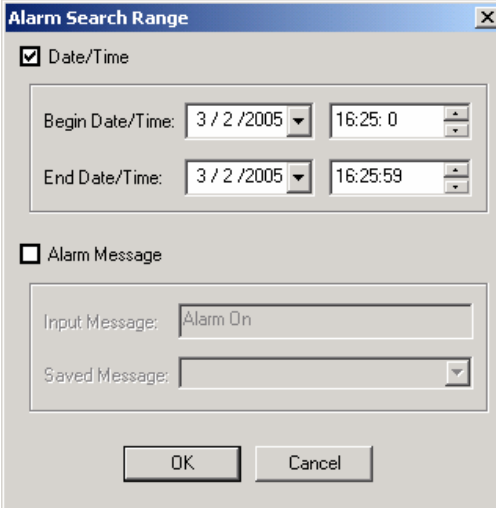

The 'Alarm Search Range' dialog box is used to filter alarm history. It features a 'Date/Time' section with 'Begin Date/Time' and 'End Date/Time' fields, each containing a date and time. Below this is an 'Alarm Message' section with an 'Input Message' text box and a 'Saved Message' dropdown menu. 'OK' and 'Cancel' buttons are at the bottom.

<input checked="" type="checkbox"/> Date/Time
Begin Date/Time: 3 / 2 / 2005 16:25: 0
End Date/Time: 3 / 2 / 2005 16:25:59
<input type="checkbox"/> Alarm Message
Input Message: Alarm On
Saved Message: [Dropdown]
OK Cancel

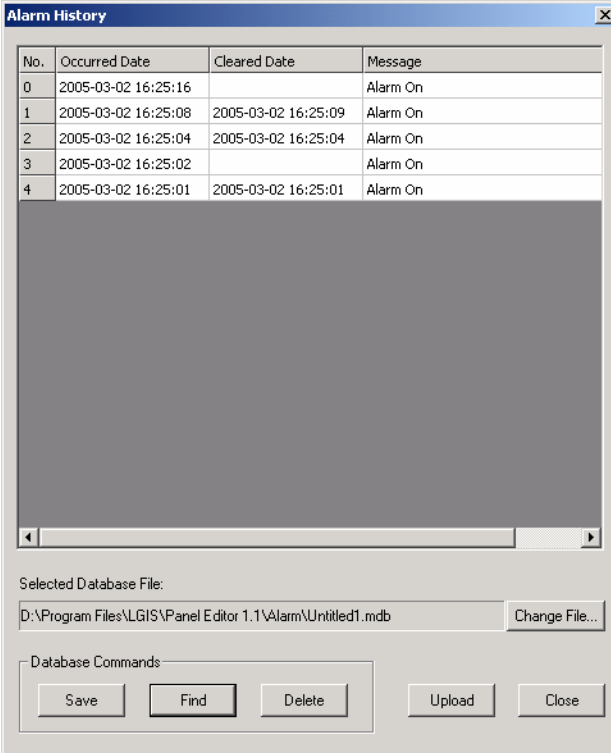

The 'Alarm History' window displays a table of alarm events. Below the table is a 'Selected Database File' field with a 'Change File...' button. At the bottom, there is a 'Database Commands' section with buttons for 'Save', 'Find', 'Delete', 'Upload', and 'Close'.

No.	Occurred Date	Cleared Date	Message
0	2005-03-02 16:25:16		Alarm On
1	2005-03-02 16:25:08	2005-03-02 16:25:09	Alarm On
2	2005-03-02 16:25:04	2005-03-02 16:25:04	Alarm On
3	2005-03-02 16:25:02		Alarm On
4	2005-03-02 16:25:01	2005-03-02 16:25:01	Alarm On

Selected Database File: D:\Program Files\LGIS\Panel Editor 1.1\Alarm\Untitled1.mdb Change File...

Database Commands: Save Find Delete Upload Close

## Chapter 6. Panel Editor

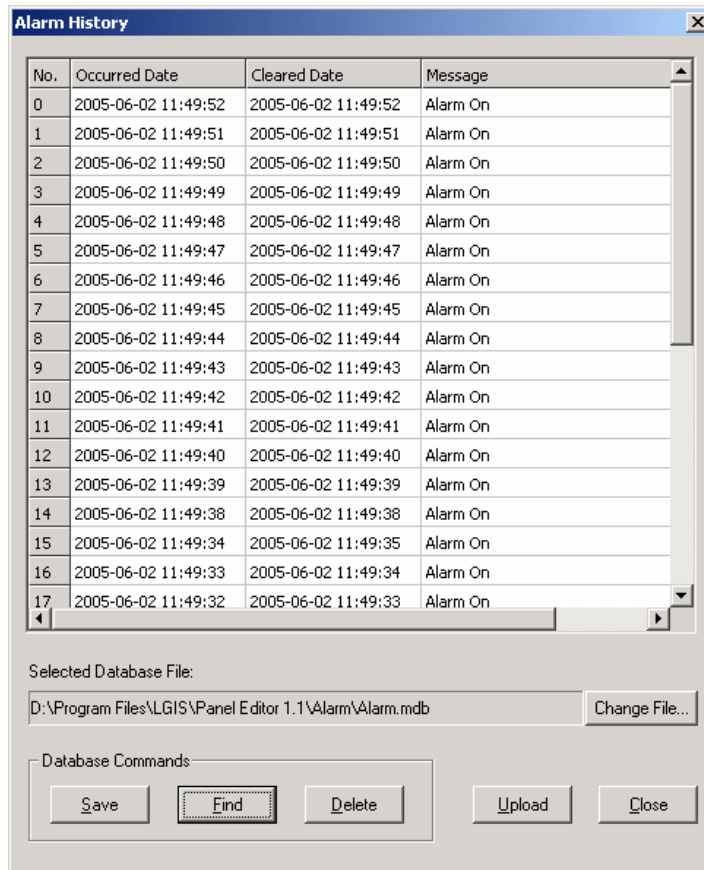

(3) After an alarm message is selected or input, click Find to search for the alarm history with the applicable message contained.

(4) If both Date and Alarm Message are selected, the alarms only correspondent to the two conditions will be found and displayed.

#### (4) Delete Selected Alarm

(1) Deletes a specific alarm.

(2) Select a specific alarm to delete and click 'Delete Selected Alarm' to display the window as below.

(3) Press 'Yes' to delete the selected alarm.

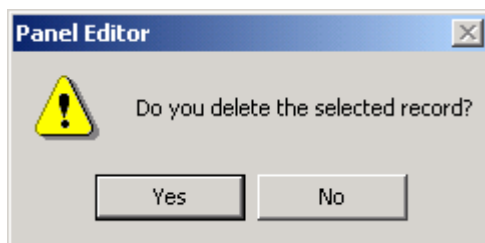

#### REMARK

1) The Search Function is only available when the uploaded alarm history is saved.

## Chapter 6. Panel Editor

### 6.12.9 Delete Alarm History

Deletes the entire alarm history saved on the XGT Panel.

Press Delete Alarm History to display the window as below.

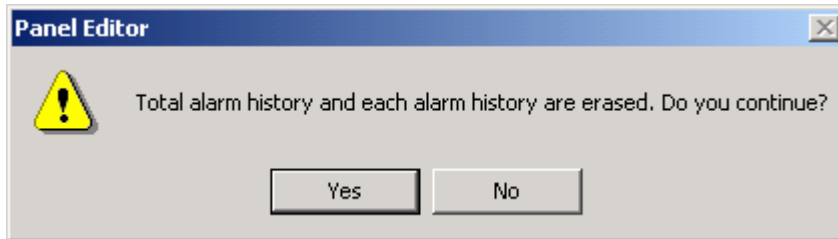

Press 'Yes' to delete the entire alarm history of the XGT Panel and the message window will be displayed as shown below.

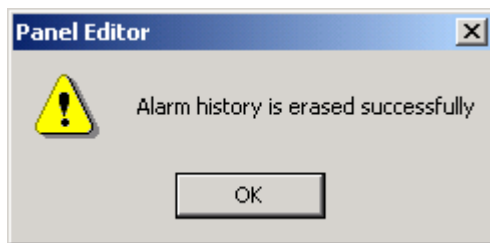

### 6.12.10 Read System Information

Reads O/S Version of the XGT Panel, Menu, Communication Driver Information, System Information, etc.

Select Read System Information to read and display the System Information as shown below.

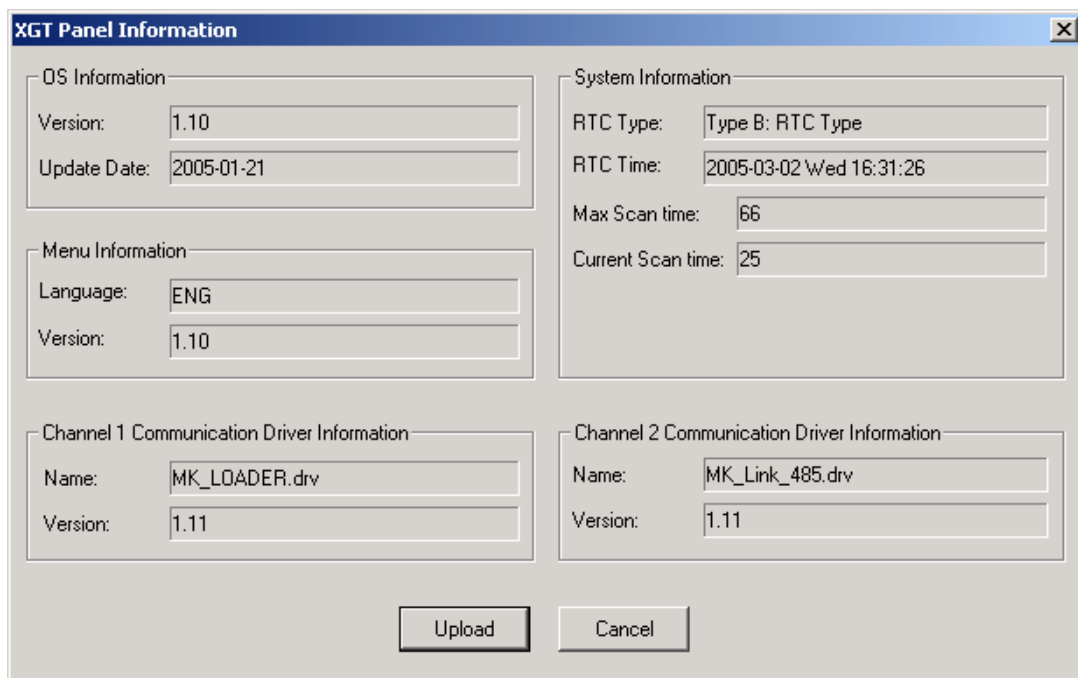

## 6.13 Tools

Explains various functions of the tools.

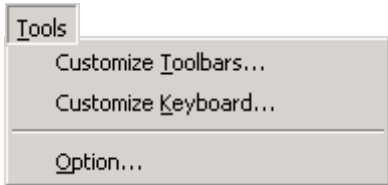

### 6.13.1 Customize Toolbars

Customizes or edits Toolbars as requested by the user.

Select Customize Toolbars to display Customize setting window as below.

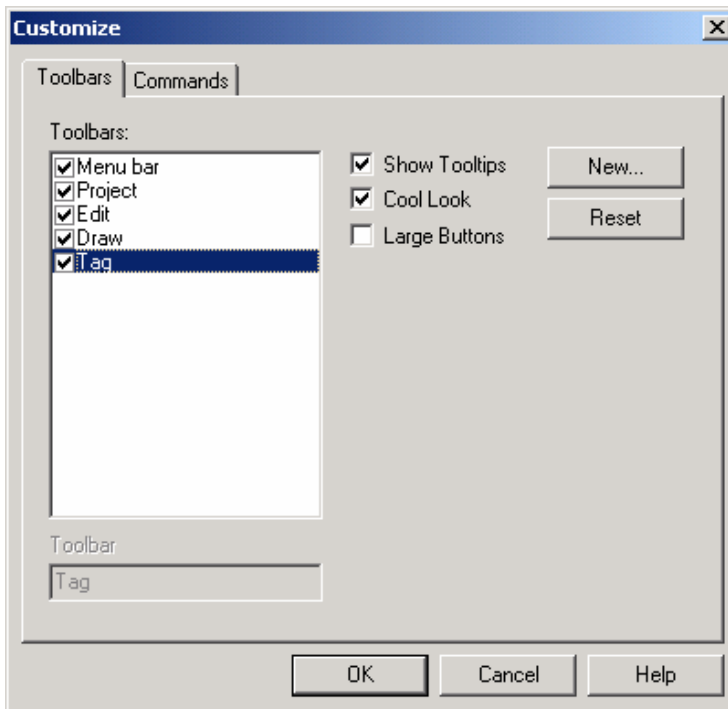

1) New Toolbar

(1) Press New Toolbar button to display the New Toolbar window as below where the name of a new toolbar can be input.

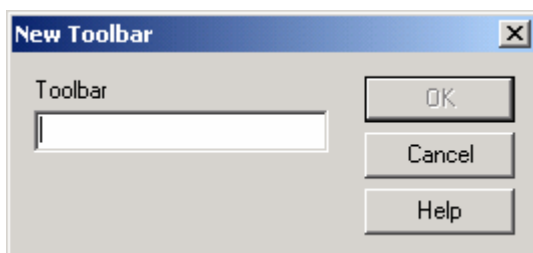



## Chapter 6. Panel Editor

(2) Input a desired name and click 'OK' to create and display a newly specified toolbar as below.

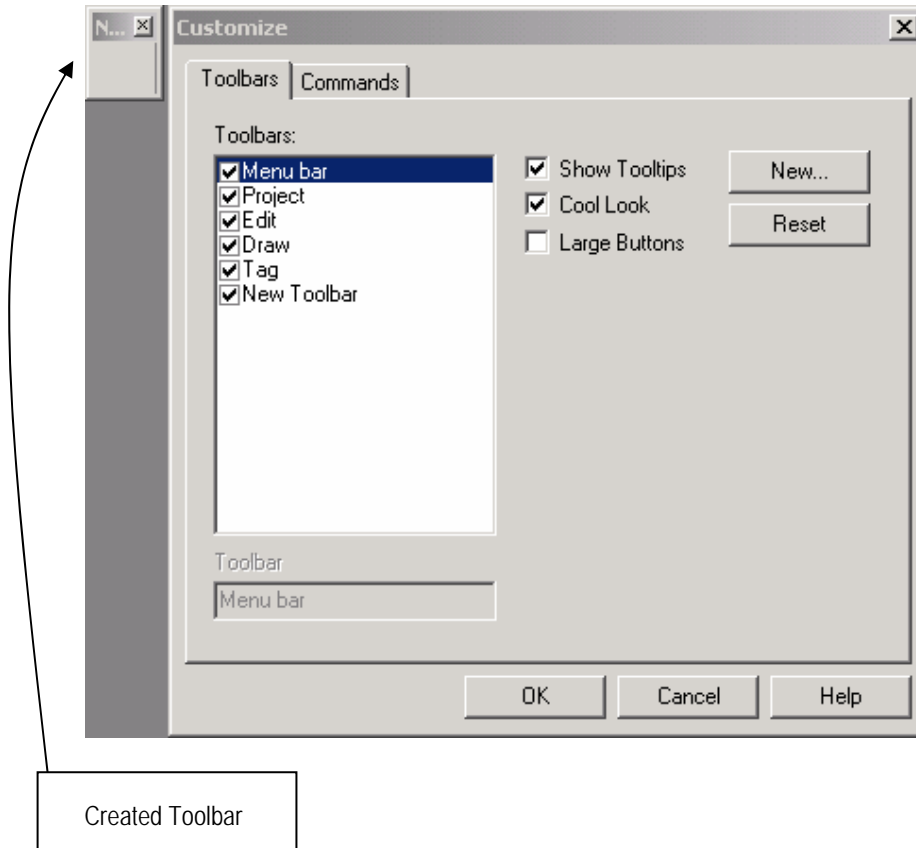

(3) Select Commands on the Customize window to display shortcut icons per function as below.

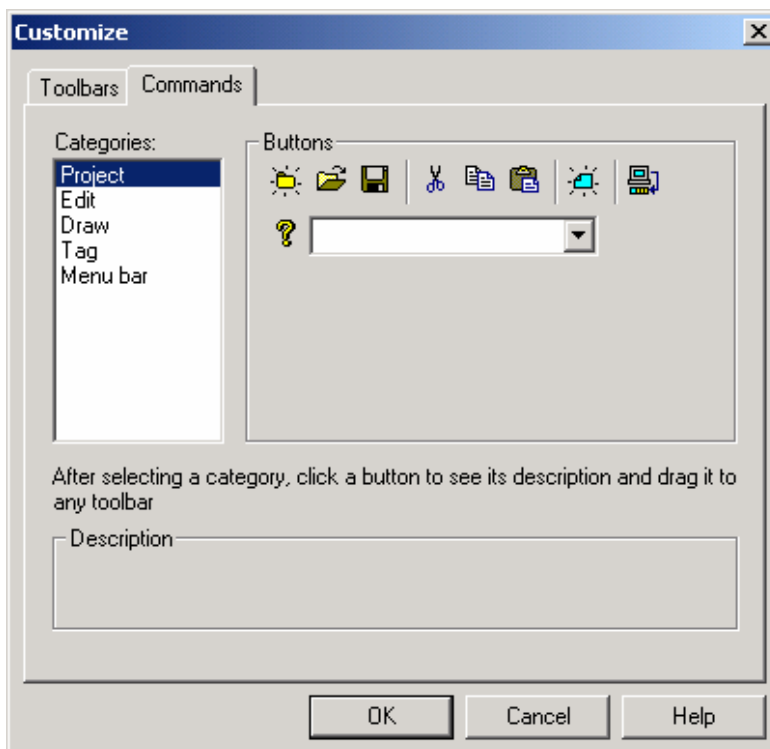

## Chapter 6. Panel Editor

---

- (4) Select icons to contain to Customized Toolbars and drag it to the New Toolbar so to add to the Toolbar.



- (5) If all are added, click 'OK' to complete Customize Toolbars.

### 2) Delete Customized Toolbars

Deletes the Customized Toolbars.

- (1) Select user's Customized Toolbars on the Toolbars and click 'Delete'.
- (2) However, basic toolbars such as Project, Edit, Draw, Tag and Menu bar can not be deleted.

### 6.13.2 Customize Shortcut Keys

Specifies various shortcut keys of the menu as requested by the user.

Select Customize Shortcut Keys to display the shortcut keys setting window as below.

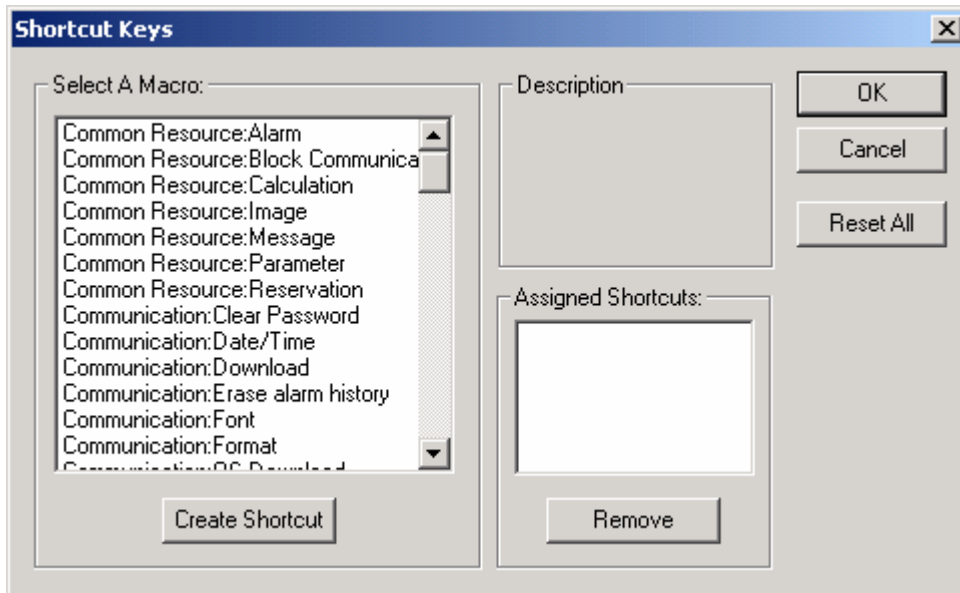

The sequence to specify shortcut keys is as follows.

- (1) From the left of the screen select the menu to specify a shortcut key and press 'New Shortcut Key' to display the Assign Shortcut window as shown below.

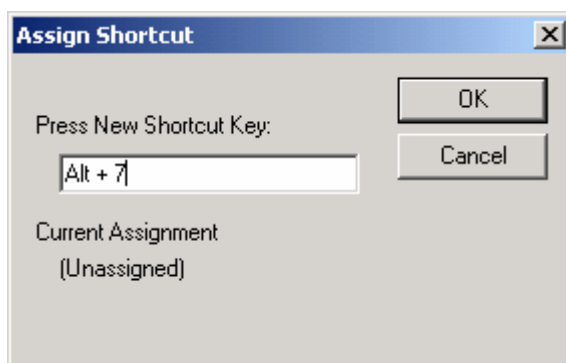

- (2) Press the key to assign as its shortcut key and click 'OK' to add the shortcut key for the applicable function as below.

## Chapter 6. Panel Editor

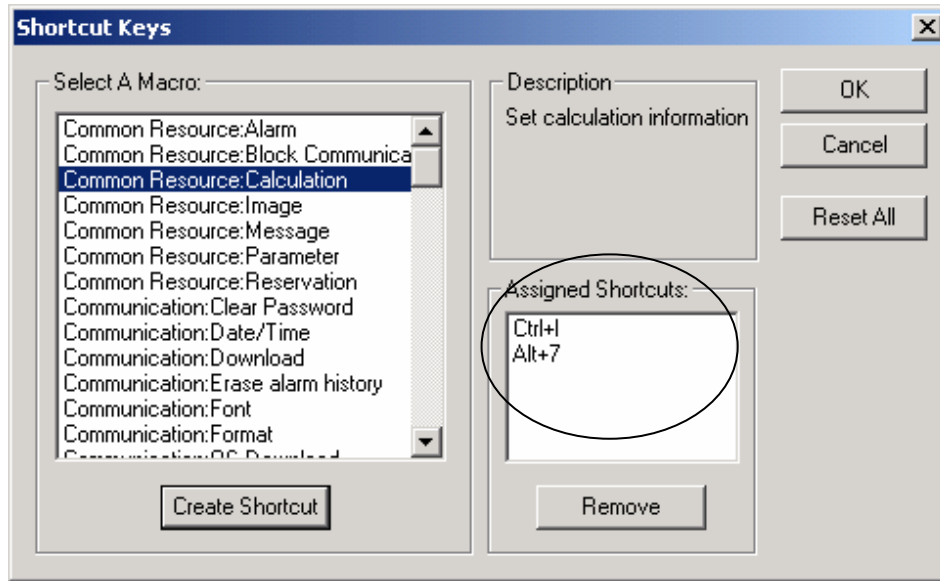

- (3) In order to delete an assigned shortcut key, select the shortcut key and click Remove to delete the applicable shortcut key.
- (4) Press Reset All to restore all the shortcut keys to default.

### 6.13.3 Option

Changes autoSave interval and various color of the Panel Editor project.

Select Option to display the Option setting window as below.

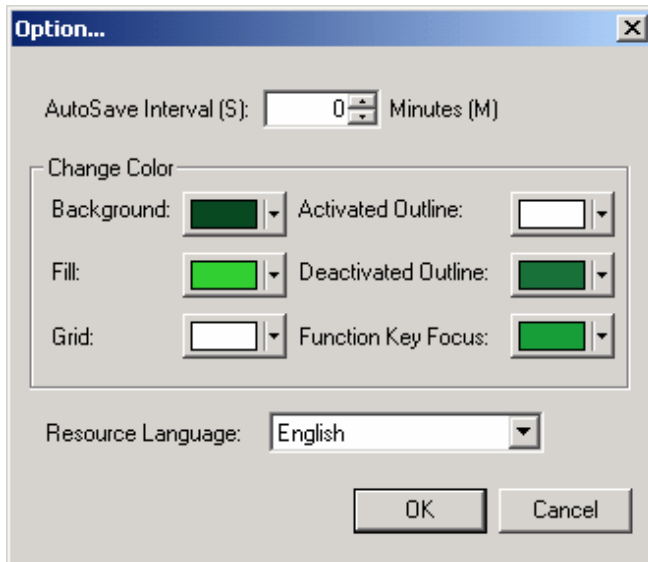

- (1) AutoSave Interval : Specifies the time interval as necessary to save the project automatically.  
Available range is 0 ~ 120 minutes. If 0 min. is specified, AutoSave will not be available.
- (2) Change Color : Changes the color of background, outline, fill, etc. as desired.
- (3) Resource Language : Selects a menu language of the Panel Editor. The change of a Resource Language should be performed when re-executed after the program is closed.

### 6.14 Window

Explains about various functions of the Window menu.

Specifies the display mode when many of the screens are open on the Screen Edit window of the Panel Editor.

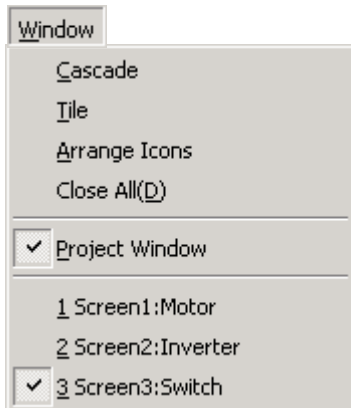

#### 6.14.1 Cascade

Arranges the open screens in Cascade mode as shown below.

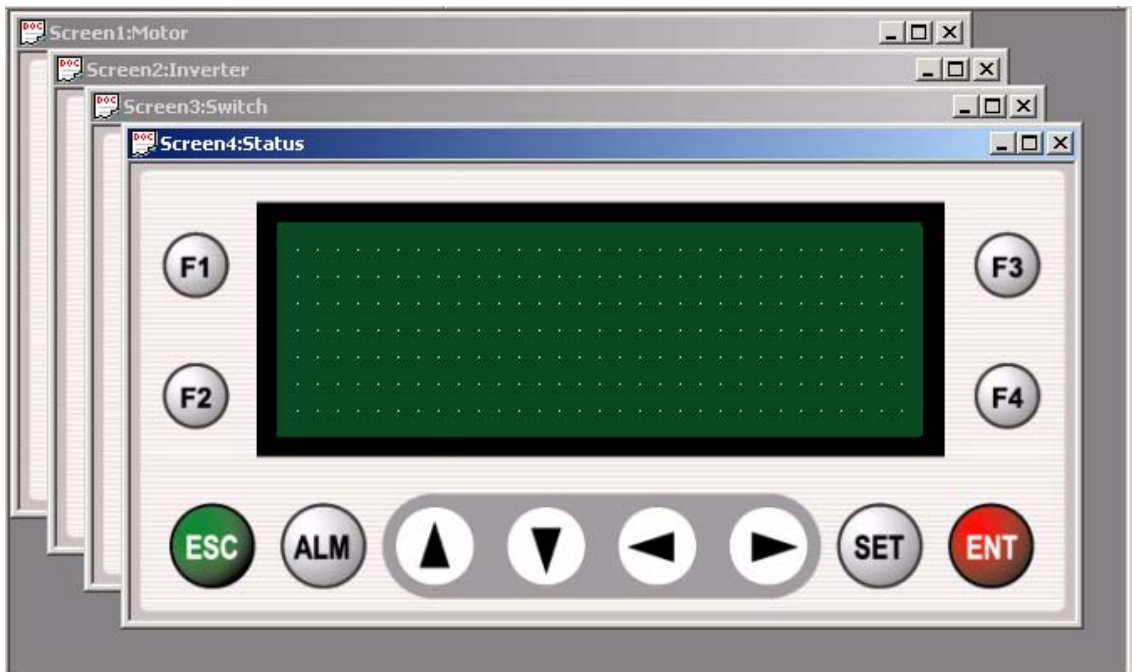

### 6.14.2 Tile

Arranges the open screens in Tile mode as shown below.

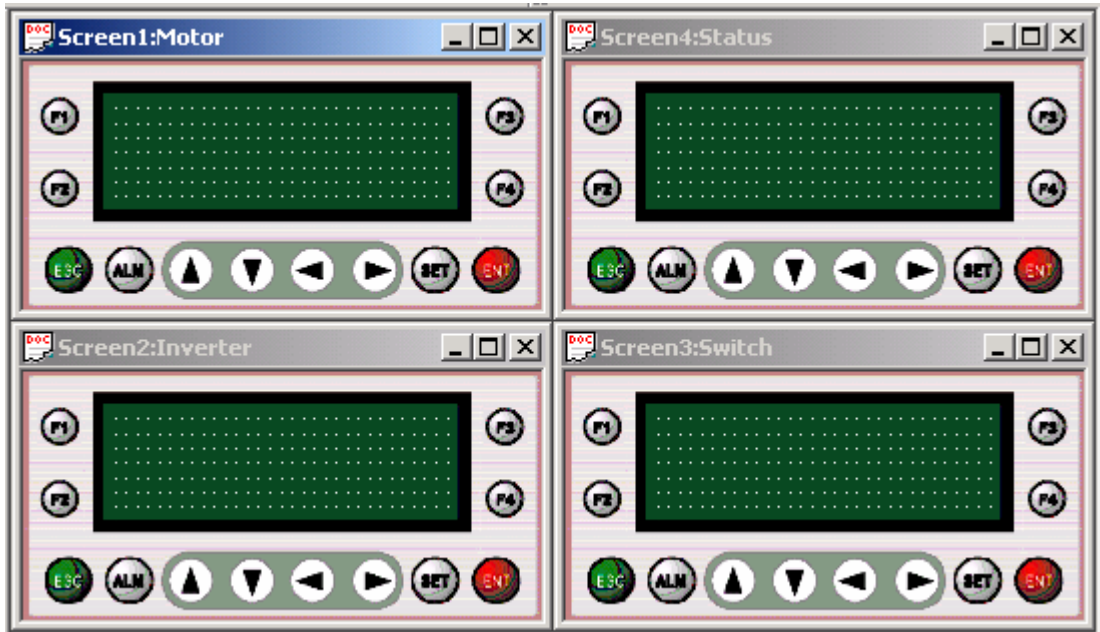

### 6.14.3 Arrange Icons

Arrange Icons minimized.

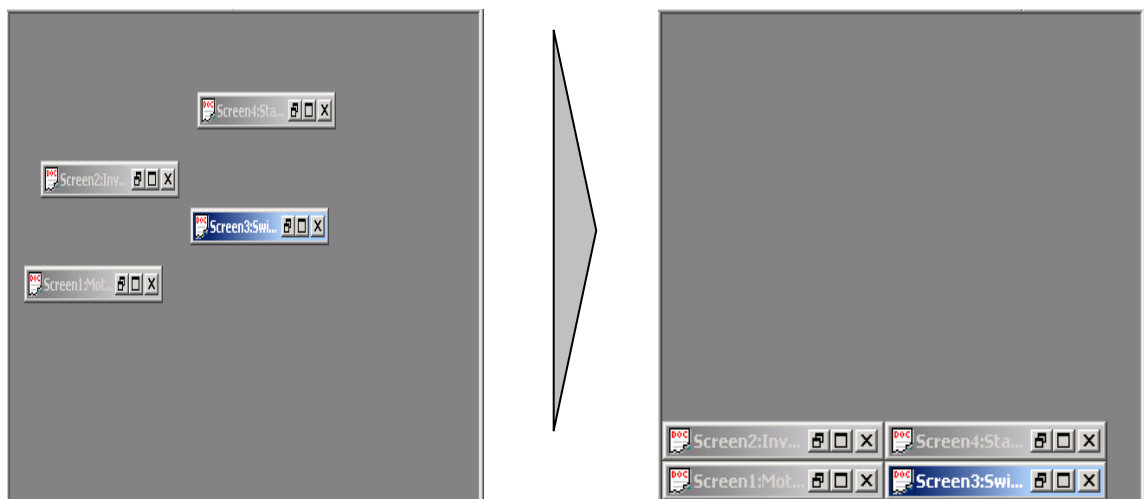

### 6.14.4 Close All

Closes all the screens presently open.

However, the screens are not deleted from the project.

### 6.15 Help

Shows the help of Panel Editor.



#### 6.15.1 About Panel Editor











## 6.16 Function Key Settings

The following explains about the function keys.

The XGT Panel offers eight function keys as shown below.

A function can be specified differently on the same function key per screen, and an identical function can be also specified for all the screens.

Key	Description	Initial function
	User defined function key 1	None
	User defined function key 2	None
	User defined function key 3	None
	User defined function key 4	None
	Arrow key (Up) (Can be defined as a function key)	None
	Arrow key (Down) (Can be defined as a function key)	None
	Arrow key (Left) (Can be defined as a function key)	Go to the previous screen
	Arrow key (Right) (Can be defined as a function key)	Go to the next screen

Click the key where a function is specified to display the function setting window as below.

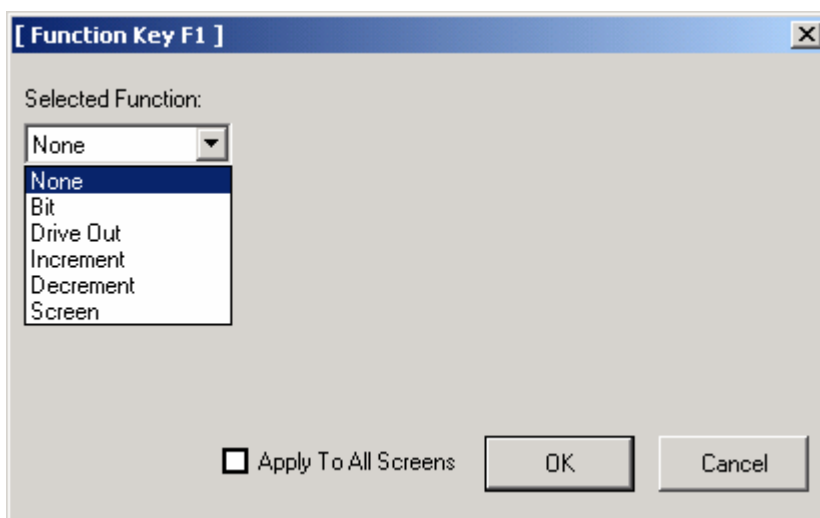



## 6.16.1 None

Specifies no function.

## 6.16.2 Bit Control

Controls status (On or Off) of bit device.

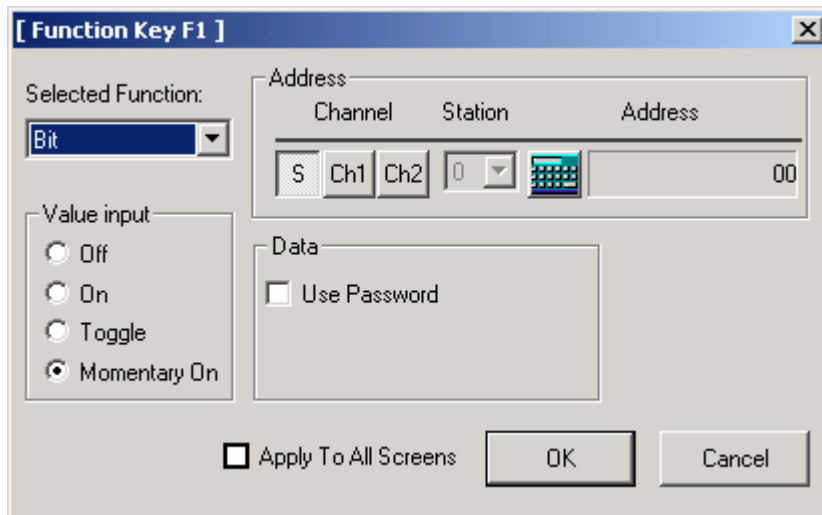

### 1) Address

- (1) Specifies an address of bit device.
- (2) Refer to the section 6.9.3 Button Tag for details.

### 2) Value input

- (1) Specifies the kind of action of the function key when pushed.

Action	Description
On	Turns on the bit device
Off	Turns off the bit device
Toggle	Turns On if the present status is Off, and turns Off if it is On.
Momentary On	Turns on the bit device while pushed.

### 3) Use Password

- (1) If this option is specified, the function keys are unavailable until the password is removed.

#### 4) Apply To All Screens

- (1) Applies the function of this function key to all screens identically if selected.
- (2) Makes the function selection menu inactive of the applicable function key on the other screens if selected, and its setting will be unavailable if not released from Apply To All Screens.

### 6.16.3 Drive Out

Changes a current value of device to specified value.

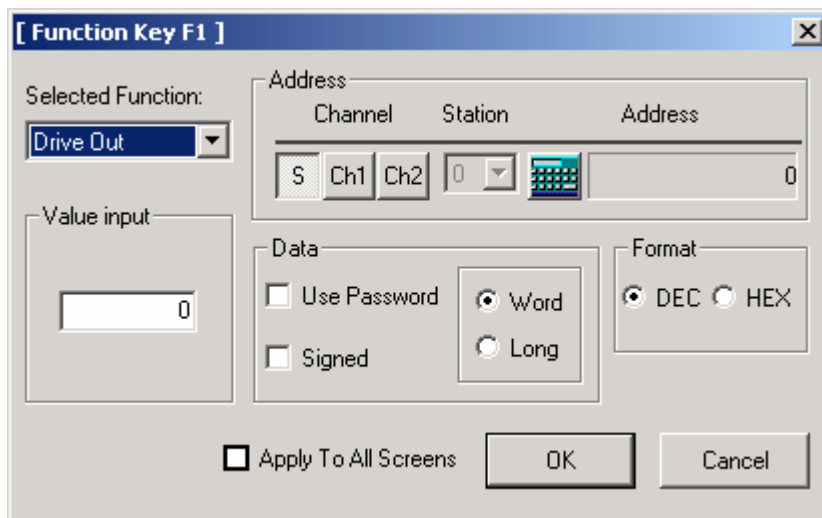

#### 1) Address

- (1) Specifies the address of a device to drive.
- (2) Refer to the section 6.9.1 Numeric Tag' for details.

#### 2) Value input

- (1) Specifies the value to write on the device if the applicable function key is pressed.
- (2) The value of specified device is changed into this value when the function key is pushed.

#### 3) Data/Format

- (1) Refer to the section '6.9.1 Numeric Tag' for details.

#### 4) Apply To All Screens

- (1) Applies the function of this function key to all screens identically if selected.
- (2) Makes the function selection menu inactive of the applicable function key on the other screens if selected, and its setting will be unavailable if not released from Apply To All Screens.

a

## 6.16.4 Increment

Increases the value of device as specified value when the function key is pushed.

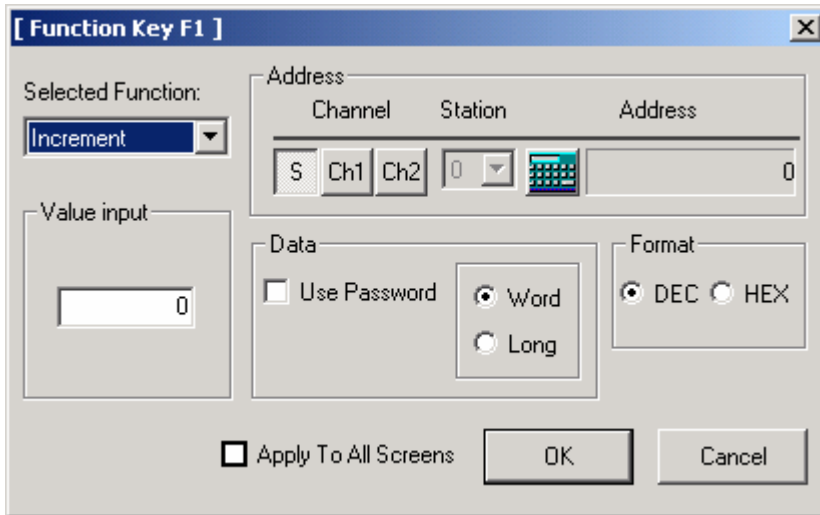

### 1) Address

- (1) Specifies the address of a device to drive.
- (2) Refer to the section '6.9.1 Numeric Tag' for details.

### 2) Value input

- (1) The value of specified device is increased as this value, when the function key is pushed.

### 3) Data/format

- (1) Refer to the section '6.9.1 Numeric Tag'.

### 4) Apply To All Screens

- (1) Applies the function of this function key to all screens identically if selected.
- (2) Makes the function selection menu inactive of the applicable function key on the other screens if selected, and its setting will be unavailable if not released from Apply to All Screens.

## 6.16.5 Decrement

Decreases the value of device as specified value when the function key is pushed.

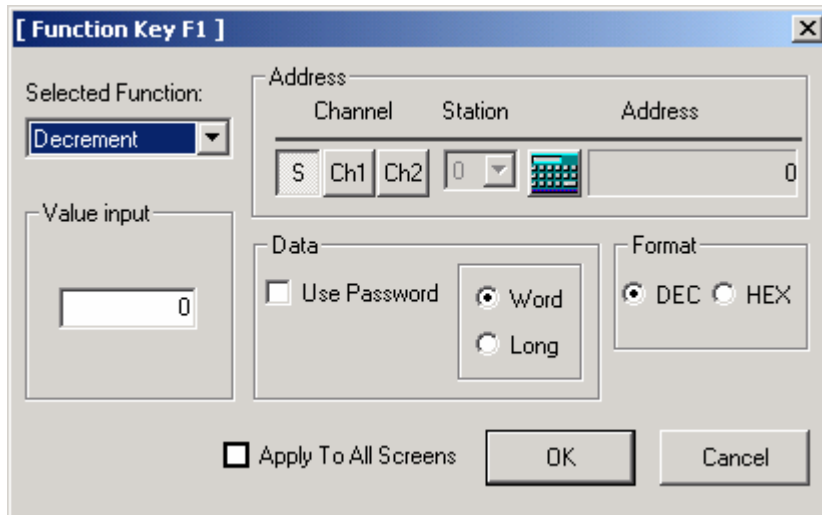

### 1) Address

- (1) Specifies the address of a device to drive.
- (2) Refer to the section '6.9.1 Numeric Tag' for details.

### 2) Value input

- (1) The value of specified device is decreased as this value when the function key is pushed.

### 3) Data/Format

- (1) Refer to section '6.9.1 Numeric Tag' for details.

### 4) Apply To All Screens

- (1) Applies the function of this function key to all screens identically if selected.
- (2) Makes the function selection menu inactive of the applicable function key on the other screens if selected, and its setting will be unavailable if not released from Apply To All Screens.

## 6.16.6 Screen

Goes to the specified screen.

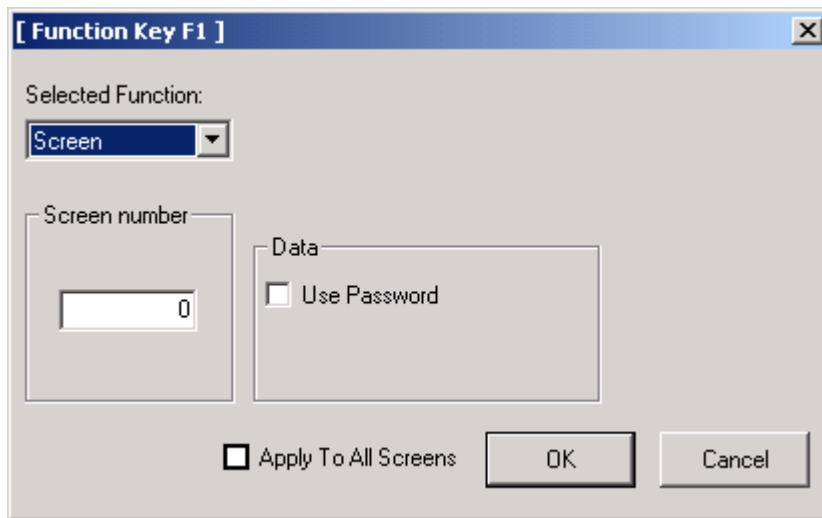

### 1) Screen number

- (1) Specifies the number of screen to go.
- (2) The function key will not be available if the selected screen does not exist.

### 2) Use Password

- (1) If Use Password selected, the password should be cancelled in the XGT Panel to make the function key available.

## Chapter 7. XGT Panel Function

### 7.1 Key Operation

#### 7.1.1 Operation Mode

The XGT Panel executes its monitoring operation.

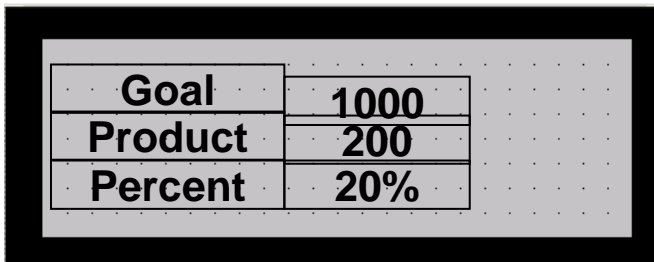

Goal	1000
Product	200
Percent	20%

#### 7.1.2 Screen Change Mode

Displays a list of screens of the XGT Panel and goes to the selected screen.

In the Operation Mode, the process sequence of the Screen Change is as follows for instance.

- (1) Press 『ESC』 key in the Operation Mode to display the screen list, when the present screen will be displayed on the reversed background as shown below.

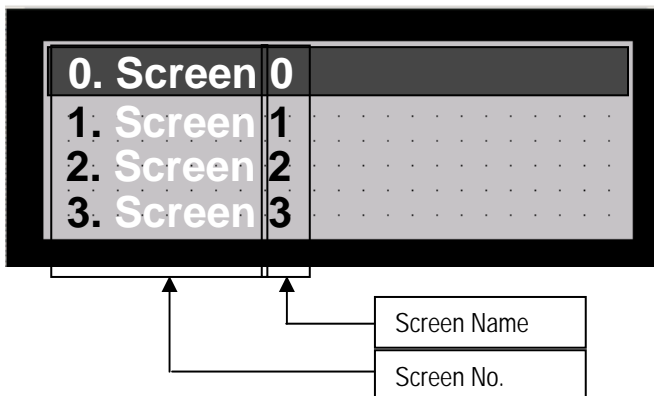

- (2) Press ▲ and ▼ keys to move the cursor to the screen to change to and then press ENT key to change to the selected screen.

### 7.1.3 Alarm History Mode

Displays a history of occurred alarms.

In the Operation Mode, the process sequence of the Alarm History is as follows for instance

Press 『ALM』 key in the Operation Mode to display the Alarm History menu screen as shown below.

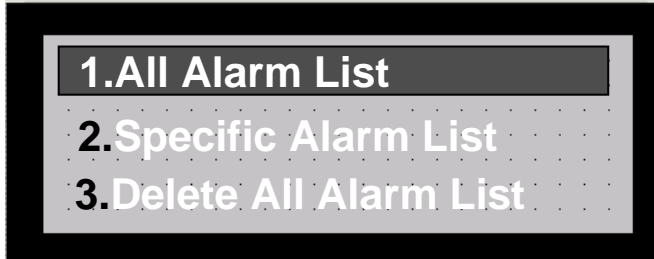

All Alarm List : Shows the history of all alarms occurred.(Max. 200 can be saved)

Specific Alarm List : Shows the history of specific alarms among all.

Delete All Alarm List : Deletes the history of all alarms occurred.

#### 1) Check All Alarm List

- (1) Locate the cursor on All Alarm List and press ENT key to display the Alarm List screen showing the history of all alarms occurred as shown below.

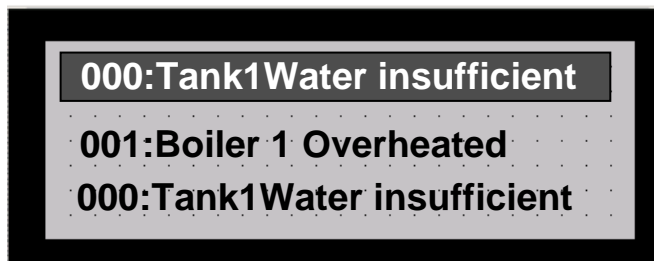

- (2) Press ▲ and ▼ keys to move to the alarm history to check and then press ENT key to display the detailed information on Alarm Message, Occurred Time, Released Time as shown below.

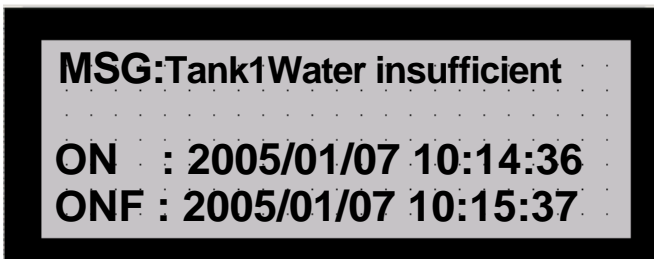

- (3) Press ESC key again to return to Alarm List screen. Press ESC key once more to return to Alarm History menu screen. Press the key once more again to return to the Operation Mode.

## Chapter 7. XGT Panel Function

---

### 2) Check Specific Alarm List

- (1) Locate the cursor on Specific Alarm List and press ENT key to display the screen showing the type of the alarm presently selected as shown below.

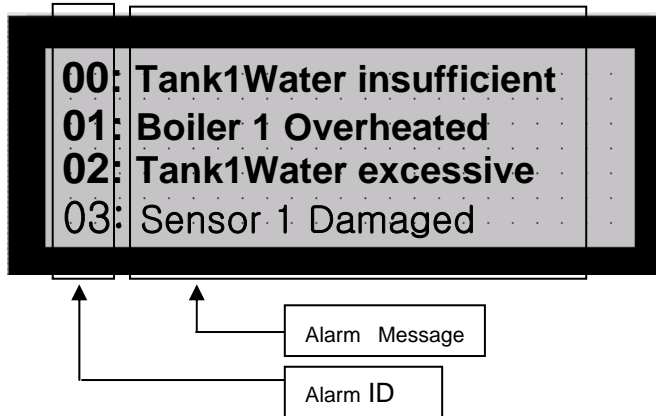

- (2) Press ▲ and ▼ keys to move to ID of the alarm history to check and then press ENT key to display the history of the applicable alarm occurred as shown below.

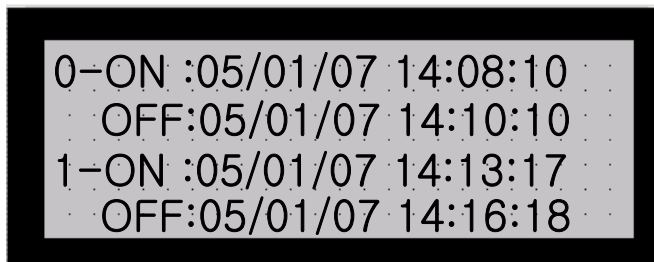

- (3) Returning to the Operation Mode is identical to '1) Check All Alarm List'.

### 3) Delete All Alarm List

- (1) Deletes all the alarms saved in the XGT Panel.
- (2) Locate the cursor on Delete All Alarm List and press ENT key to display the confirmation screen as below.

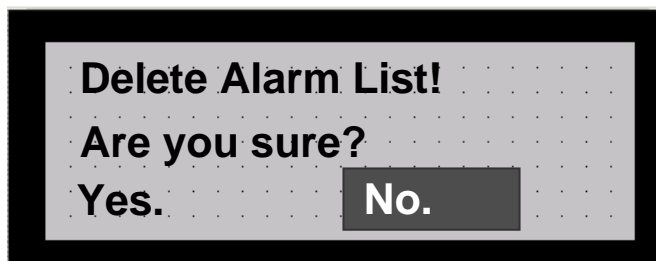

- (3) Move the cursor on 'Yes' and press ENT to delete All Alarm List. Pay attention! If the Alarm List is once deleted, it is not possible to recover.



## Chapter 7. XGT Panel Function

### 4) Alarm Occurrence Screen

(1) The screen below represents the case an alarm condition has occurred during the operation of XGT Panel.

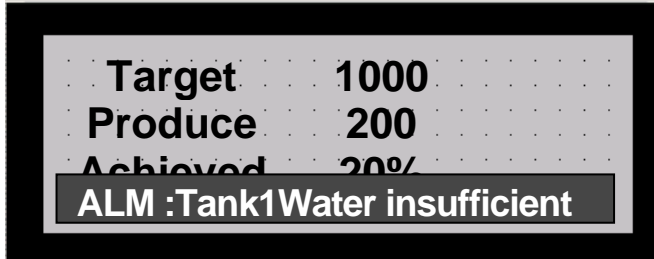

(2) If an alarm occurs, an alarm message specified in the bottom of the screen blinks.

(3) If a buzzer is set, it will ring as specified.

(4) At this moment, other keys than ESC and ALM will not operate.

### 7.1.4 XGT Panel System Menu Mode

Performs system related setting of XGT Panel such as Set Password, Cancel Password, Date/Time, Buzzer Volume, Backlight, Download Speed, etc.

#### 1) Convert to System Menu Mode

(1) In order to convert to System Menu Mode from Operation Mode press both ENT and ESC keys or press ENT key for 2 seconds at least, when a system mode screen will be displayed as shown below.



(2) Menu available in the System Menu Mode is as follows.

Menu	Description
Cancel Password	Makes Write Operation of the tag available although Write Password is specified.
Lock Password	Limits Write Operation of the tag if Write Password is specified.
Edit Password	Edits the presently specified password.
Date/Time Setting	Confirms and changes the time of built-in RTC.
Buzzer Volume	Controls the volume of the buzzer(OFF, LOW and HIGH).
Backlight	Decides whether to use the backlight or not.
Download Speed	Specifies Download Speed from the Panel Editor.
System Information	Shows OS version and driver information of Ch1 & Ch2.

## Chapter 7. XGT Panel Function

---

### 2) Cancel Password

Cancels the presently specified password of the XGT Panel.

If the password is canceled, Write Operation of the tag becomes available although Write Password is specified thereon.

- (1) In the System Menu move the cursor to '1.Cancel Password' and press ENT key to display the Password Input screen as shown below.

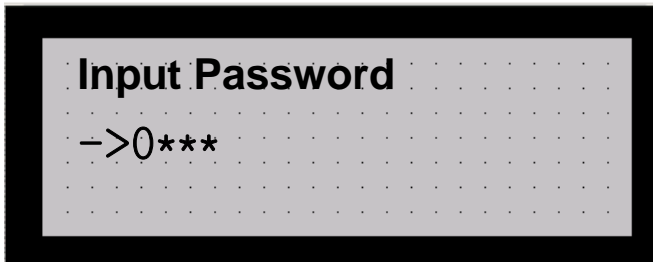

- (2) Input the correct password and press ENT key to cancel the password. If an incorrect password is input, the password will not be canceled.

### 3) Lock Password

- Locks the presently specified password of the XGT Panel.
- If the password is locked, Write Operation of the tag where Write Password is specified becomes unavailable.

- (1) In the System Menu move the cursor to '2. Lock Password' and press ENT key to lock the password as shown below.

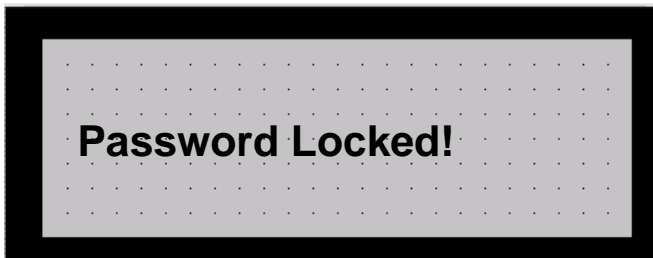

### 4) Edit Password

- Edits the presently specified password of the XGT Panel.

- (1) In the System Menu move the cursor to '3.Edit Password' and press ENT key to display the Edit Password screen as shown below.

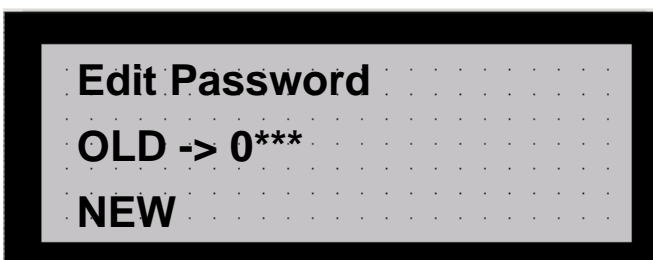

## Chapter 7. XGT Panel Function

---

(2) If the previous password is correctly input, press ENT key to move the cursor to NEW. Then, input a New Password and press ENT key to change the password.

### 5) Date/Time Set

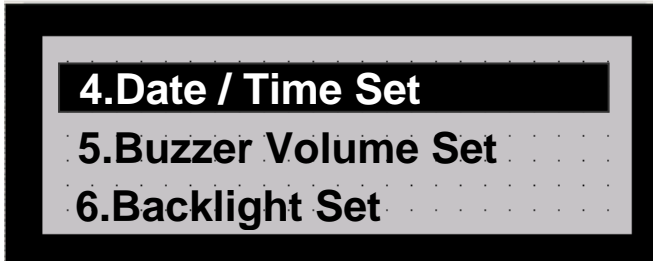

- Displays Date/Time of built-in RTC of the XGT Panel as necessary to specify differently.
- However, Date/Time Setting is only available at XP10BKB/DC.

(1) In the System Menu move the cursor to '4. Date/Time Setting' and press ENT key to display the present Date/Time as shown below.

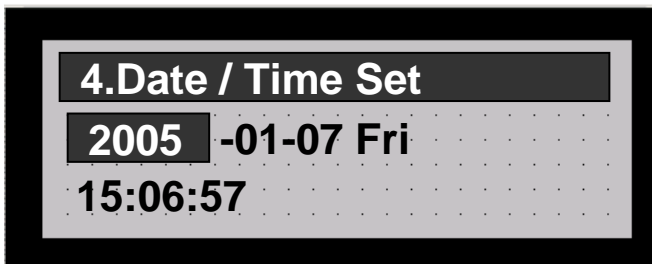

(2) Press SET key to display the cursor. Use the Up/Down/Left/Right arrow keys to specify desired Date and Time. Then, press ENT key to change Date/Time. However, the day of the week If not applicable to the date specified will not be changed.

### 6) Buzzer Volume Set

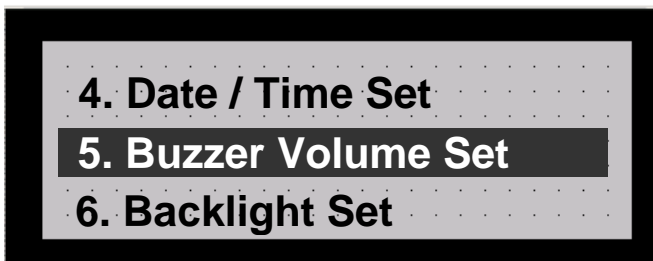

Specifies a volume of the buzzer.

Available volume is OFF, LOW and HIGH.

## Chapter 7. XGT Panel Function

---

- (1) In the System Menu move the cursor to '5.Buzzer Volume Setting' and press ENT key to display the Buzzer Volume setting screen as shown below.

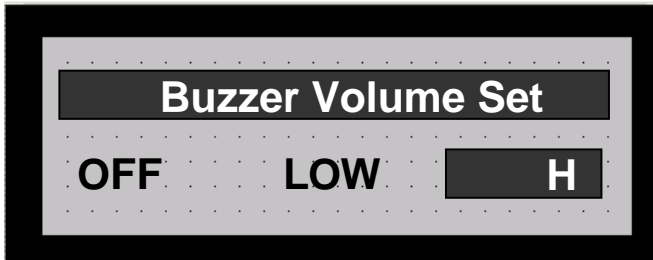

- (2) Move the cursor to desired volume option and press ENT key to complete the Volume Setting.
- (3) Press ESC key to return to System Menu Mode.
- (4) Even if the power is off, the Buzzer Volume once specified will be permanently preserved until reset.

### 7) Backlight Set

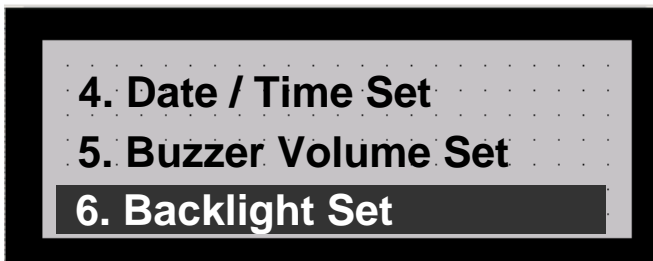

Specifies Backlight On / Off.

- (1) In the System Menu move the cursor to '6. Backlight Setting' and press ENT key to display the Backlight Setting screen as shown below.

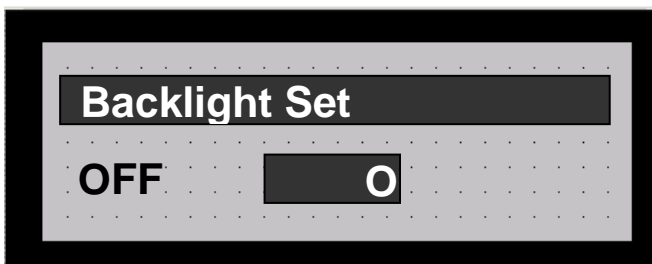

- (2) Move the cursor to OFF or ON as necessary and press ENT key to complete the Backlight Setting.
- (3) Press ESC key to return to System Menu Mode.
- (4) If the power is turned back ON after once turned OFF, the Backlight will return to default (ON).

### 8) Download Speed

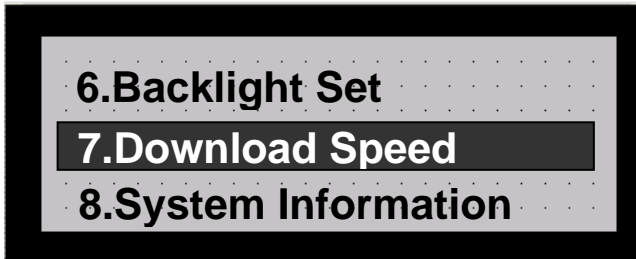

Specifies the speed when Downloading/Uploading the project through the Panel Editor.

Default is fixed at 115,200bps.

Communication Speed of 9,600, 38,400 and 115,200bps are available to specify for various PC environment.

- (1) In the System Menu move the cursor to "7.Download Speed" and press ENT key to display the Download Speed Setting screen as shown below.

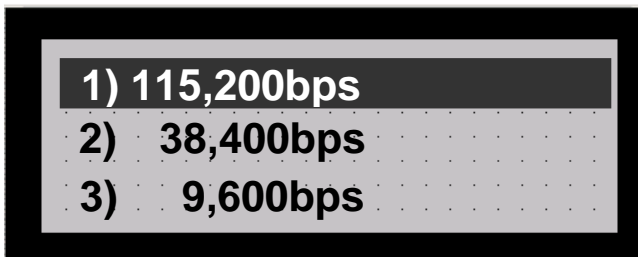

- (2) Move the cursor to the desired Download Speed and press ENT key to change the Download Speed.

- (3) Press ESC key to return to System Menu Mode.

- (4) Even if the power is off, the Download Speed once specified will be permanently preserved until reset.

- (5) For the successful Download/Upload, the Download Speed of the XGT Panel and the Panel Editor should be set identical to each other.

### 9) System Information

Shows O/S version and driver O/S information of the XGT Panel.



## Chapter 7. XGT Panel Function

---

- (1) In the System Menu move the cursor to "8. System Information" and press ENT key to display the System Information as shown below.

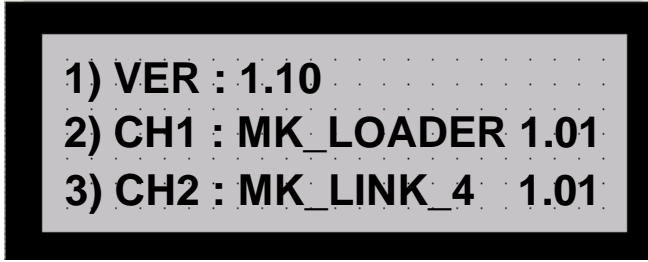

VER: Displays O/S version information of the XGT Panel.

CH1: Displays the communication driver and O/S version information of the RS-232C Channel.

CH2: Displays the communication driver and O/S version information of the RS-422/485 Channel.

- (2) Press ESC key to return to System Menu Mode.

### 7.2 Operation Mode

#### 7.2.1 Monitoring Mode

The XGT Panel executes its monitoring operation.

##### 1) Display Data

Each tag reads the current value of the specified device from the instrument connected with so to display in the mode as specified.

If more than two tags are overlapped, the tag that was drawn on the top layer hidden from the other tags.

In case that the power is initially turned On and that the screen or the mode is changed, its applicable value will be displayed on the screen if the communication succeeds or there is no response for a specified Timeout duration.

##### 2) Communication Error

(1) No response: In case of no response due to cable connection or communication problems, the tag displays 0 after the specified timeout duration. Thereupon, Error Count(COM\*\_COUNT) of the system buffer increases by 1 and the error details are saved in Error Code(COM\*\_ERROR).

(2) Incorrect response: In case of incorrect response due to invalid communication frames or other communication problems, the tag displays 0. Thereupon, Error Count (COM\*\_COUNT) of the system buffer increases by 1 and the error details are saved in Error Code (COM\*\_ERROR)..

##### 3) Error Code & Error Count

The Communication Error Code & Error Count will be saved respectively per channel in the following inner memory.

(1) CH1: Error Count - COM1\_COUNT (916), Error Code - COM1\_ERROR (917)

(2) CH2: Error Count - COM2\_COUNT (918), Error Code - COM2\_ERROR (919)

Error code	Error condition and causes
H0001	The length of the received frame is over 256 bytes.
H0010	The result of BCC check is wrong.
H0020	The data of received frame are invalid.
H0040	The received data cannot be converted to HEX format.
H0080	The received frame is not a complete frame.
H6020	No response.

### 7.2.2 Key

#### 1) Function key

Executes a defined function. It does not operate if it is not defined. Refer to the section 6.1.6 for details.

#### 2) ESC key

Shows the list of defined screen. It is possible to move to the screen selected.

For more details about changing screen, refer to the section 7.1.2 Screen Change Mode.

#### 3) ALM key

Changes current mode to the alarm history mode.

For more details about alarm history mode, refer to the section '7.1.3 Alarm History Mode'

#### 4) SET key

Changes current mode to the value-changing mode if the tag which is enabled to write exists.

For more details about value-changing mode, refer to the section 6.9.

#### 5) If ENT key (Min. 2 seconds) is pressed or if both ENT key and ESC key are pressed,

8 items on the displayed menu of the XGT Panel are as follows.

1. Cance Password
2. Lock Password
3. Edit Password
4. Data/Time Set
5. Buzzer Volume Set
6. Backlight Set
7. Download Speed
8. System Information

For more details, refer to '7.1.4 XGT Panel System Menu Mode'.



### 7.3 Changing Screen

There are 4 ways to change the screen of XGT Panel.

#### 7.3.1 By Function Keys

The screen can be changed to another screen by a key which is defined as the screen change function.

In this case, password for the key operation can be set.

As a default, ◀ is defined as previous screen and ▶ is defined as next screen.

For more details, refer to 6.16 Key Operation.

#### 7.3.2 From the Screen List

On the list of the screens, after selecting a screen to go, then push ENT key.

For more details, refer to 7.1.2 Screen Change Mode.

#### 7.3.3 By Screen Saver

When the screen saver option is enabled, if no key is input during specified time duration, the screen goes to the specified screen.

For more details, refer to 6.11.3 Parameter Setting.

#### 7.3.4 By Online Screen Change

When the online screen change option is enabled,

In case that online screen change is set, the screen goes to the screen correspondent to the value of device.

For more details, refer to 6.11.3 Parameter Settings.

#### REMARK

1) Screen changing operates on the rising edge of input.

The screen changed by a function is available to change to another screen by a different function.

2) If there is no registered screen to go, the screen-changing function does not operate.

### 7.4 Alarm

#### 7.4.1 Alarm Message

When an alarm occurs, the alarm message will be displayed at the bottom of the screen.

In this case, all tags operate normally except the area that is covered by the alarm message.

When an alarm occurs, any other key input than ESC and ALM is ignored.

If the Alarm is removed after its occurrence, whether to keep the message displayed or not is available to specify in the Alarm setting.

The displayed alarm message is a last one.

If other alarm occurs while one alarm has already occurred, the message of the latest alarm will be displayed.

#### 7.4.2 Alarm Buzzer

If the alarm buzzer is specified, the buzzer operates when an alarm occurs.

The buzzer stops its operation if ESC or ALM key is pushed.

#### 7.4.3 Alarm History

For the occurred alarms, their histories are saved.

There are two alarm histories, [All alarm history] and [Specific alarm history].

Refer to the section 7.1.3 Alarm History Mode for the details.

##### (1) All Alarm List

(1) In order it happened recently, the latest alarm is saved at 0.

(2) If alarms have occurred over 200, the earliest alarm will be erased.

(3) In case of XP10BKB/DC, the date/time of alarms occurred and removed will be saved in addition to alarm messages.

##### (2) Specific Alarm List

(1) Alarm history is saved for each specific alarm. (Available on XP10BKB/DC only)

(2) Displays the history of a specific alarm in order it occurs. The date and time of occurrence and removal will be only displayed for each history.

(3) If individually specific alarms have occurred over 10, the earliest alarm will be erased to save a new specific alarm.

(4) Download the parameter from the Panel Editor to delete the Specific Alarm List.

### 7.5 Buzzer

#### 7.5.1 Buzzer Operation

The Buzzer Operates in the following condition

Condition	Volume	Remark
When key is pushed	The size to be set	Valid key input: 1 time Invalid key input: 3 times
When the data communication with Panel Editor is completed	HIGH	Program data up/download Font data download Data/time set Password set/clear
When alarm is occurred	HIGH	When the buzzer is enabled

### 7.6 System Memory

#### 1) User area (S0 ~ 899: 900 word)

- (1) Can be used for calculation, block communication and so on. User area is erased when the power goes off.
- (2) However, in case of XP10BKB/DC type, the area specified as latch area is saved when the power goes off.

#### 2) System flag (S900 ~ 999: 100 word)

- (1) Used for system flags. (Refer to Appendices for the details about system flags)
- (2) Undefined area is a reserved area.

# Chapter 8. Communication Driver

This section explains XGT Panel connectable devices, wiring and communication settings.

## 8.1 Driver Download

When a project drawn on the Panel Editor is downloaded, the Panel Editor confirms information of the communication driver downloaded on the present XGT Panel per channel.

If an identical driver to the project to download is already present at the XGT Panel, others than the driver will be only downloaded. In case a different driver from the present project exists, the driver will be automatically downloaded.

At this moment, not only the type but the version of the driver will be checked so to automatically download the driver if even its version is not identical. All the process above will be executed automatically on the Panel Editor for the user to keep from any special operation.

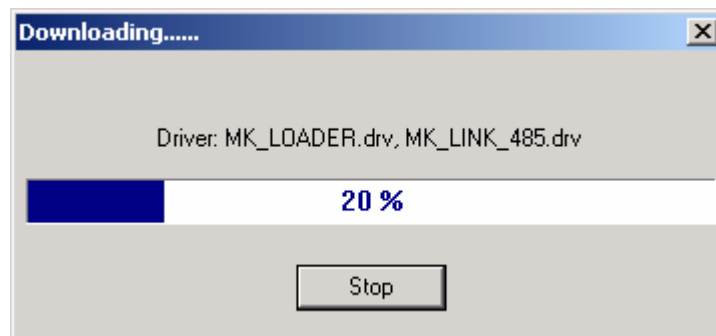

**8.2 LS MASTER-K Series (80S/120S/200S/300S/1000S) Loader Protocol**

**8.2.1 Communication Mode**

Connection is available through LS MASTER-K series of PLC and the Loader Protocol. Since Communication Speed and Communication Set are fixed, LS MASTER-K series of Loader if selected makes the Communication Setting button inactive, thus setting is unavailable.

Setting Item	Setting Contents	Remarks
Communication Mode	RS-232C	CH2 Unavailable
Instrument Sided Connector	9pin Male connector	-
Connection Protocol	MASTER-K Loader Protocol	-
Communication Speed	38,400bps	Fixed (Setting unavailable)
Data Bit	8 Bits	
Parity Bit	None	
Stop Bits	1 Bit	
Station No.	None	

**8.2.2 Connection Available Device**

Device range of LS MASTER-K series of PLC where Read or Write is available with the XGT Panel connected to is as follows.

Max. range of the connection available device is diverse based on the connected type of PLC.

Max. available range is displayed in here. For more information on the Max. device range of each PLC, refer to the user's manual of the applicable PLC.

Device	Connection Available Area			Remarks
	Bit	Word	Long	
D Area	D00000 –D4999F	D0000 –D4999	D0000 –D4998	Ex.) D0000F : DO's bit 15
T Area	T0 –T255	T0 –T255	T0 –T254	
C Area	C0 –C255	C0 –C255	C0 –C254	
P Area	P000 –P63F	P00 –P63	P00 –P62	
M Area	M0000 –M191F	M000 –M191	M000 –M190	
L Area	L000 –L63F	L000 –L063	L000 –L062	
K Area	K000 –K31F	K000 –K031	K000 –K030	
F Area	F000 –F63F	F000 –F063	F000 –F062	Read dedicated
S Area	-	S00 –S99	S00 –S98	Bits Read unavailable

## 8.2.3 Connection Diagram

If the Loader Protocol is used, the Connection Diagram of XGT Panel and MASTER-K series is as shown below. Use the Connection Diagram button of PLC Type Change on the Panel Editor to check the Connection Diagram below.

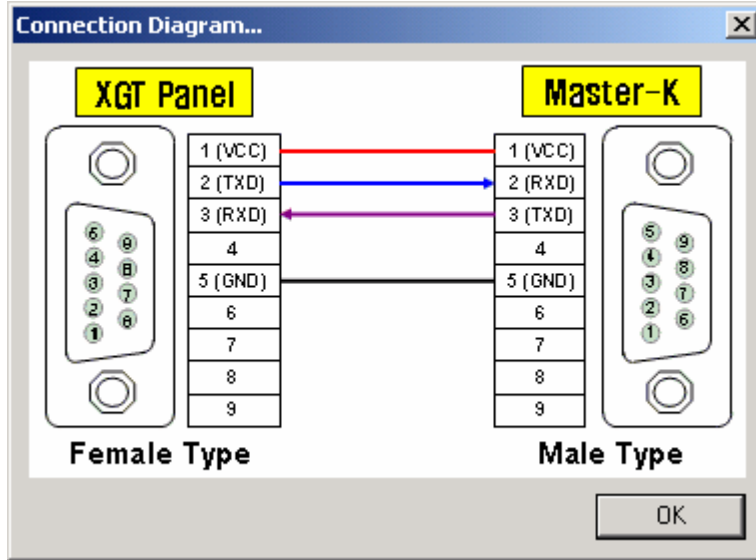

### 8.3 LS MASTER-K Series (80S/120S/200S/300S/1000S) : Dedicated Protocol

#### 8.3.1 Communication Mode

Connection is available through LS MASTER-K series of PLC and the Dedicated Protocol.

If connected with LS MASTER-K series and the Dedicated Protocol, its applicable communication setting is as follows.

At this moment, the applicable communication setting of PLC and the XGT Panel to be connected between should be set identical to each other.

Setting Item	Setting Contents		Remarks
	CH 1	CH 2	
Communication Mode	RS-232C	RS-422, RS-485	-
Instrument Sided Connector	9-Pin Male connector	Terminal plate or connector	-
Connection Protocol	MASTER-K Dedicated Protocol		-
Communication Speed	1,200/2,400/4,800/9,600/19,200/38,400/57,600bps		
Data Bit	7Bits, 8Bits		
Parity Bit	None, Even Bits, Odd Bits		
Stop Bits	1 Bit, 2 Bits		
Station No.	0 ~ 31		Station No. unavailable if identical to XGT Panel

#### 8.3.2 Connection Available Device

The range of the connection available device with the Dedicated Protocol used is as specified in 8.2.2 'MASTER-K Loader Protocol'.

Device	Connection Available Area			Remarks
	Bit	Word	Long	
D Area	D00000 –D4999F	D0000 –D4999	D0000 –D4998	Ex.) D0000F : D0's bit 15
T Area	T0 –T255	T0 –T255	T0 –T254	
C Area	C0 –C255	C0 –C255	C0 –C254	
P Area	P000 –P63F	P00 –P63	P00 –P62	
M Area	M0000 –M191F	M000 –M191	M000 –M190	
L Area	L000 –L63F	L000 –L063	L000 –L062	
K Area	K000 –K31F	K000 –K031	K000 –K030	
F Area	F000 –F63F	F000 –F063	F000 –F062	Read dedicated
S Area	-	S00 –S99	S00 –S98	Bits Read unavailable

8.3.3 Connection Diagram

If the Dedicated Protocol is used, the Connection Diagram of XGT Panel and MASTER-K series is as shown below. Use the Connection Diagram button of PLC Type Change on the Panel Editor to check the Connection Diagram below.

1) CH 1(if connected with RS-232C used)

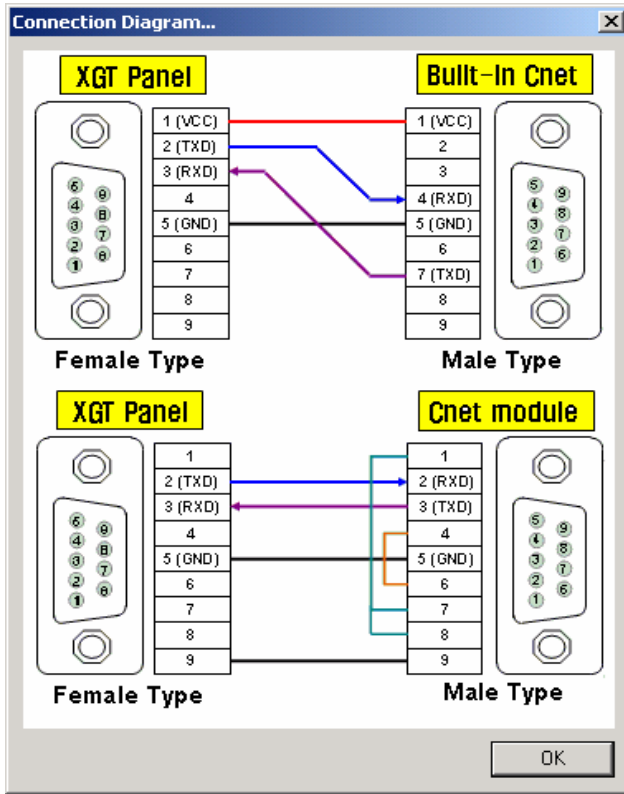

2) CH 2(if connected with RS-422/485 used)

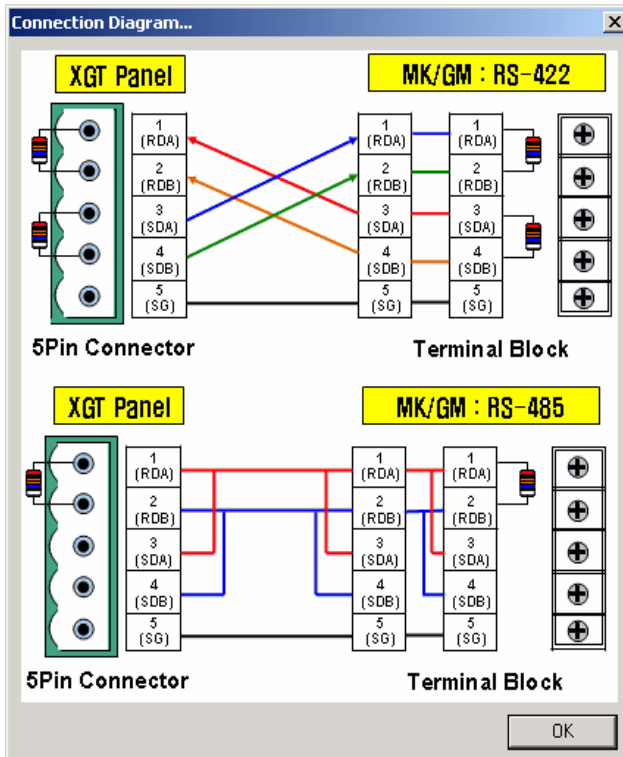



**8.4 LS MASTER-K10S1 : Dedicated Protocol**

**8.4.1 Communication Mode**

Connection is available through LS MASTER-K10S1 PLC and the Dedicated Protocol.  
 If connected with LS MASTER-K10S1 and the Dedicated Protocol, its applicable communication setting is as follows.  
 At this moment, the applicable communication setting of MASTER-K10S1 and the XGT Panel to be connected between should be set identical to each other.

Setting Item	Setting Contents		Remarks
	CH 1	CH 2	
Communication Mode	RS-232C (232/485 onverter necessary)	RS-422, RS-485	
Instrument Sided Connector	Terminal plate	Terminal plate or connector	
Connection Protocol	MASTER-K Dedicated Protocol		
Communication Speed	1,200/2,400/4,800/9,600/19,200bps		
Data Bit	8Bits		
Parity Bit	None		
Stop Bits	1 Bit		
Station No.	0 ~ 31(1F)		Station No. unavailable if identical to XGT Panel

**8.4.2 Connection Available Device**

The range of the connection available device if connected with K10S1 is as follows.

Device	Connection Available Area			Remarks
	Bit	Word	Long	
D Area	-	D0000 –D0063	D0000 –D0062	Bits Read unavailable
T Area	T0 –T47	T0 –T47	T0 –T46	
C Area	C0 –C15	C0 –C15	C0 –C14	
P Area	P00 –P1F	P00 –P01	P00	Ex.) P0F : P0's bit 15
M Area	M00 –M15F	M00 –M15	M00 –M14	
L Area	L00 –L07F	L00 –L07	L00 –L06	
K Area	K00 –K07F	K00 –K007	K00 –K06	
F Area	F000 –F15F	F000 –F015	F000 –F014	Read dedicated
S Area	-	S00 –S15	S00 –S14	Bits Read unavailable

### 8.4.3 Connection Diagram

The Connection Diagram between XGT Panel and MASTER-K10S1 is as shown below.  
Use the Connection Diagram button of PLC Type Change on the Panel Editor to check the Connection Diagram below

- 1) CH 1 (if connected with RS-232C used)

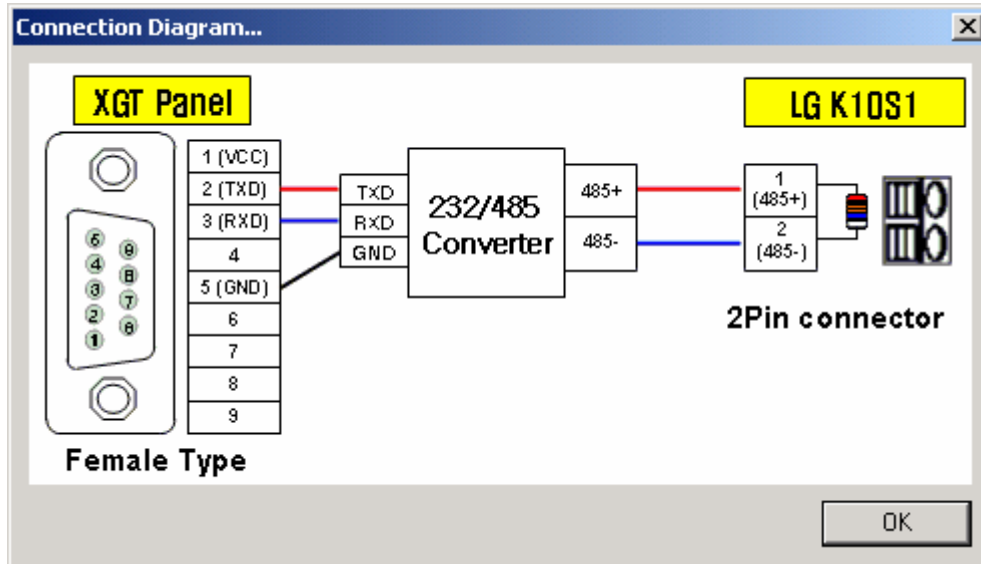

- 2) CH 2 (if connected with RS-422/485 used)

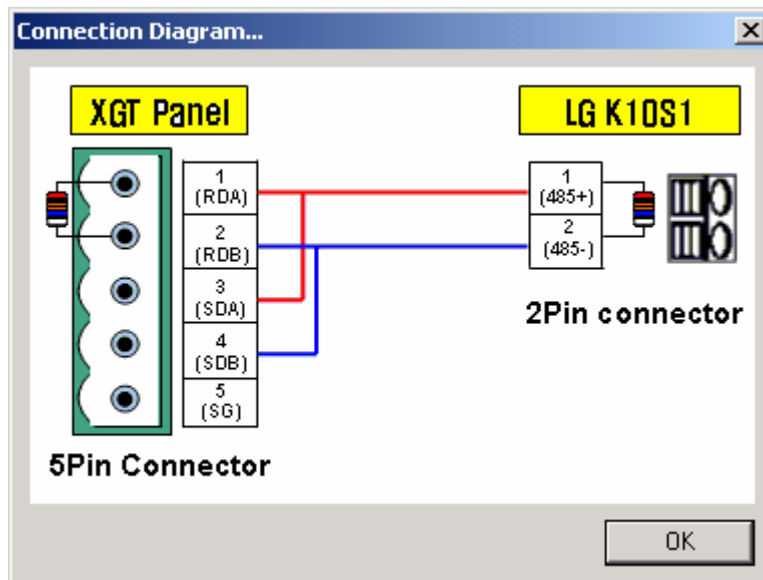

### 8.5 LS MASTER-K Series (10S/30S/60S/100S) : Dedicated Protocol

#### 8.5.1 Communication Mode

Connection is available through LS MASTER-K10/30/60/100S PLC and the Dedicated Protocol.  
If connected with LS MASTER-K10/30/60/100S and the Dedicated Protocol, its applicable communication setting is as follows.  
At this moment, the applicable communication setting of PLC and the XGT Panel to be connected between should be set identical to each other.

Setting Item	Setting Contents		Remarks
	CH 1	CH 2	
Communication Mode	RS-232C (232/485converter necessary)	RS-422, RS-485	
Instrument Sided Connector	2-Pin connector		
Connection Protocol	MASTER-K Dedicated Protocol		
Communication Speed	1,200/2,400/4,800/9,600/19,200bps		
Data Bit	8Bits		
Parity Bit	None		
Stop Bits	1 Bit		
Station No.	0 ~ 31(H'1F)		Station No. unavailable if identical to the XGT Panel

#### 8.5.2 Connection Available device

The range of the connection available device if connected with MASTER-K10/30/60/100S is as follows.  
Max. range of the connection available device is diverse based on the connected type of PLC.  
Max. available range is displayed in here. For more information on the Max. device range of each PLC, refer to the user's manual of the applicable PLC.

Device	Connection Available Area			Remarks
	Bit	Word	Long	
D Area	-	D000 –D255	D000 –D254	Bits Read unavailable
T Area	T0 –T127	T0 –T127	T0 –T126	
C Area	C0 –C127	C0 –C127	C0 –C126	
P Area	P00 –P5F	P00 –P05	P00 –P04	Ex.) P0F : P0's bit 15
M Area	M00 –M31F	M00 –M31	M00 –M30	
L Area	L00 –L15F	L00 –L15	L00 –L14	
K Area	K00 –K15F	K00 –K15	K00 –K14	
F Area	F000 –F15F	F000 –F015	F000 –F014	Read dedicated
S Area	-	S00 –S31	S00 –S30	Bits Read unavailable

### 8.5.3 Connection Diagram

The Connection Diagram of XGT Panel and MASTER-K10/30/60/100S is as shown below..  
Use the Connection Diagram button of PLC Type Change on the Panel Editor to check the Connection Diagram below.

1) CH 1(if connected with RS-232C used)

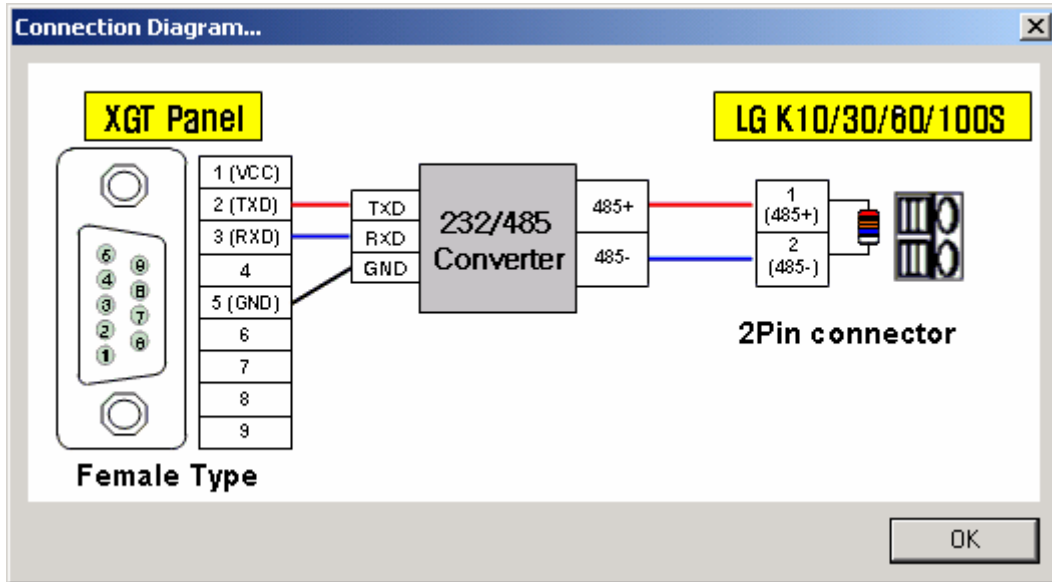

2) CH 2(if connected with RS-422/485 used)

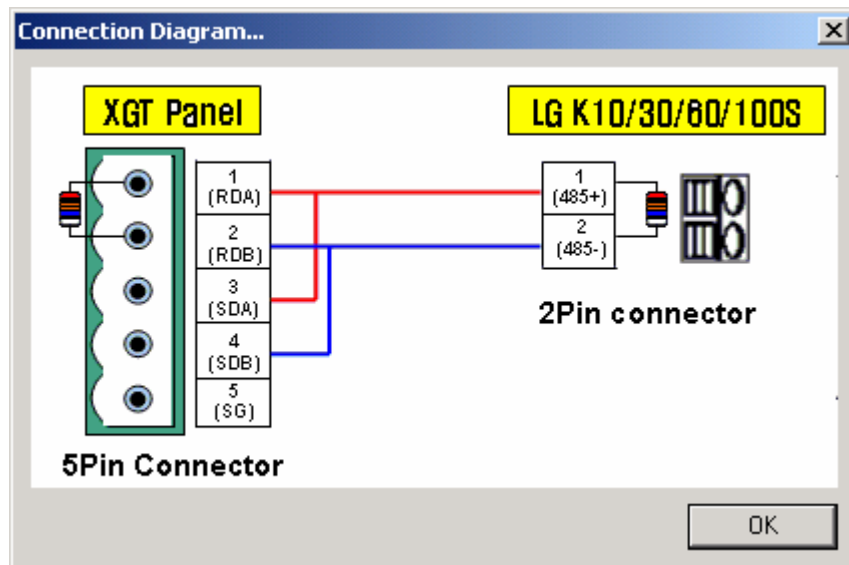

### 8.6 LS MASTER-K500H/1000H : Dedicated Protocol

#### 8.6.1 Communication Mode

Connection is available through LS MASTER-K500H/1000H PLC and the Dedicated Protocol.  
 If connected with LS MASTER-K500H/1000H and the Dedicated Protocol, its applicable communication setting is as follows.  
 At this moment, the applicable communication setting of PLC and the XGT Panel to be connected between should be set identical to each other.

Setting Item	Setting Contents		Remarks
	CH 1	CH 2	
Communication Mode	RS-232C	RS-422, RS-485	
Instrument Sided Connector	9-Pin Male connector	25-Pin Male connector	
Connection Protocol	Dedicated Protocol		
Communication Speed	1,200/2,400/4,800/9,600/19,200bps		
Data Bit	8Bits		
Parity Bit	None		
Stop Bits	1 Bit		
Station No.	0 ~ 31		Station No. unavailable if identical to the XGT Panel

#### 8.6.2 Connection Available Device

The range of the connection available device if connected with LS MASTER-K500H/1000H is as follows  
 Max. range of the connection available device is diverse based on the connected type of PLC.  
 Max. available range is displayed in here. For more information on the Max. device range of each PLC, refer to the user's manual of the applicable PLC.

Device	Connection Available Area			Remarks
	Bit	Word	Long	
D Area	-	D0000 –D4999	D0000 –D4998	Bits Read unavailable
T Area	T0 –T255	T0 –T255	T0 –T254	
C Area	C0 –C255	C0 –C255	C0 –C254	
P Area	P000 –P63F	P00 –P63	P00 –P62	Ex.) POF : PO's bit 15
M Area	M0000 –M191F	M000 –M191	M000 –M190	
L Area	L000 –L63F	L00 –L63	L00 –L62	
K Area	K000 –K31F	K00 –K31	K00 –K30	
F Area	F000 –F63F	F000 –F063	F000 –F062	Read dedicated
S Area	-	S00 –S99	S00 –S98	Bits Read unavailable

**8.6.3 Connection Diagram**

The Connection Diagram of XGT Panel and LS MASTER-K500H/1000H is as shown below.  
 Use the Connection Diagram button of PLC Type Change on the Panel Editor to check the Connection Diagram below.

1) CH 1(if connected with RS-232C used)

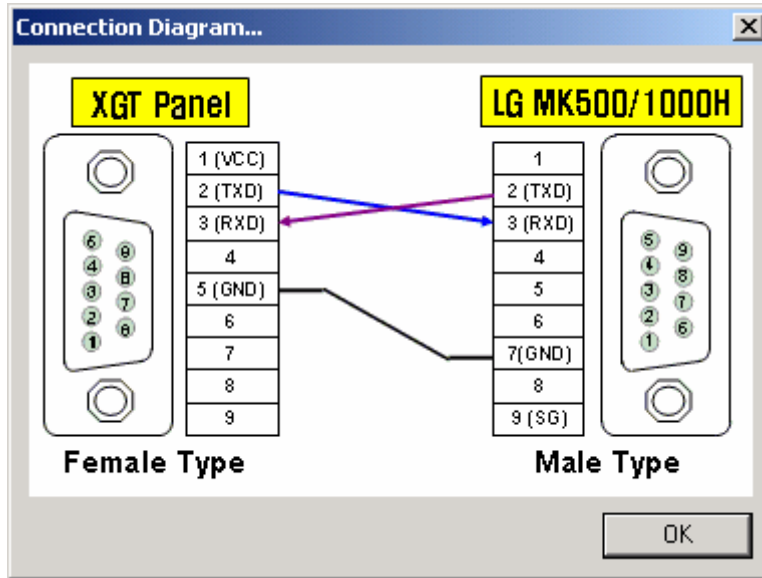

2) CH 2(if connected with RS-422/485 used)

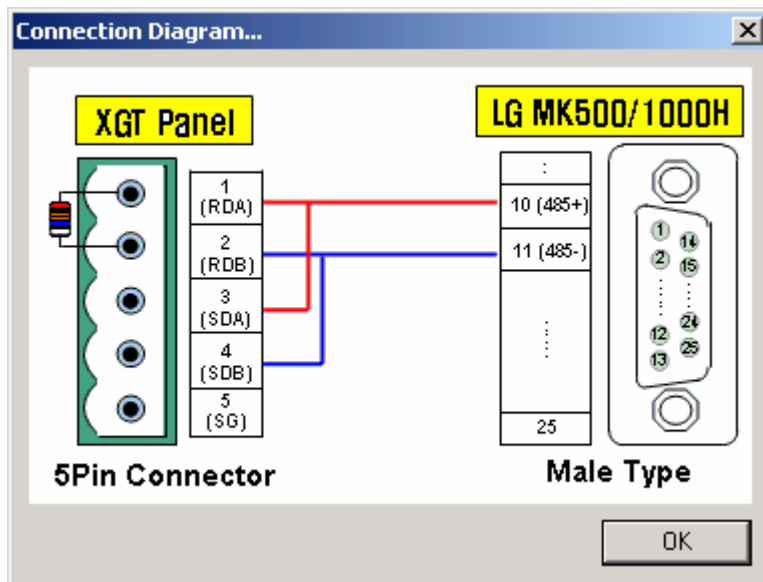

### 8.7 LS GLOFA GM Series : Loader Protocol

#### 8.7.1 Communication Mode

Connection is available through LS GLOFA GM series of PLC and the Loader Protocol.

If connected with LS GLOFA GM series and the Loader Protocol, its applicable communication setting is as follows.

At this moment, the applicable communication setting of PLC and the XGT Panel to be connected between should be set identical to each other.

Setting Item	Setting Contents	Remarks
Communication Mode	RS-232C	CH2 Unavailable
Instrument Sided Connector	9pin Male connector	-
Connection Protocol	GLOFA GM Loader Protocol	-
Communication Speed	38,400bps	Fixed (Setting unavailable)
Data Bit	8Bits	
Parity Bit	None	
Stop Bits	1 Bit	
Station No.	None	

#### 8.7.2 Connection Available device

The range of the connection available device if connected with LS GLOFA GM series is as follows.

Max. range of the connection available device is diverse based on the connected type of PLC.

Max. available range is displayed in here. For more information on the Max. device range of each PLC, refer to the user's manual of the applicable PLC.

Device	Connection Available Area			Remarks
	Bit	Word	Long	
I Area	%IX0.0.0 - 63.7.63	%IW0.0.0 - 63.7.3	%IW0.0.0 - 63.7.1	
Q Area	%QX0.0.0 - 63.7.63	%QX0.0.0 - 63.7.3	%QX0.0.0 - 63.7.1	
M Area	%MX0 - %MX524272	%MW0-%MW32767	%MW0-%MW32766	
	%MW0.0- %MW32767.15			
S Area	%SX0 - %SX524272	%SW0-%SW32767	%SW0-%SW32766	
	%SW0.0-%SW32767.15			

### 8.7.3 Connection Diagram

The Connection Diagram of XGT Panel and LS GLOFA GM series is as shown below.  
Use the Connection Diagram button of PLC Type Change on the Panel Editor to check the Connection Diagram below.

- 1) CH 1 (if connected with RS-232C used)

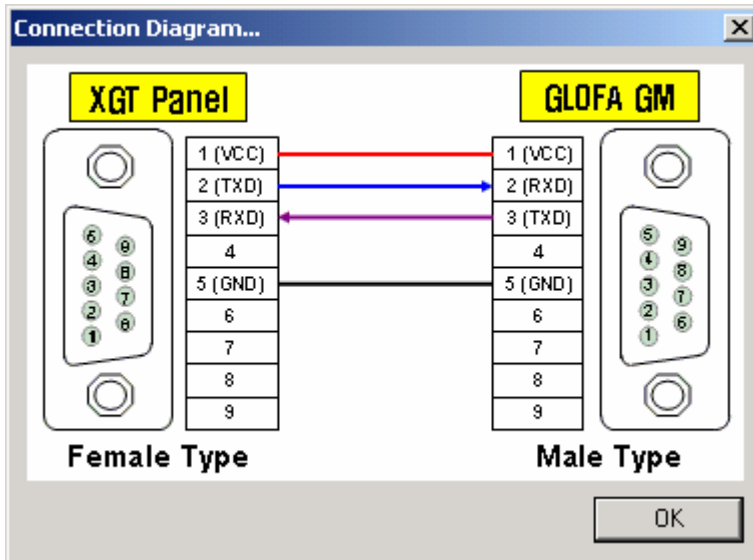



**8.8 LS GLOFA GM Series : Dedicated Protocol**

**8.8.1 Communication Mode**

Connection is available through LS GLOFA GM series of PLC and the Dedicated Protocol.  
 If connected with LS GLOFA GM series and the Dedicated Protocol, its applicable communication setting is as follows.  
 At this moment, the applicable communication setting of PLC and the XGT Panel to be connected between should be set identical to each other.

Setting Item	Setting Contents		Remarks
	CH 1	CH 2	
Communication Mode	RS-232C	RS-422, RS-485	-
Instrument Sided Connector	9pin Male connector	Terminal plate or connector	-
Connection Protocol	GLOFA Dedicated Protocol		-
Communication Speed	1,200/2,400/4,800/9,600/19,200/38,400/57,600bps		
Data Bit	7Bits, 8Bits		
Parity Bit	None, Even Bits, Odd Bits		
Stop Bits	1 Bit, 2 Bits		
Station No.	0 ~ 31		Station No. unavailable if identical to XGT Panel

**8.8.2 Connection Available device**

The range of the connection available device if connected with the Dedicated Protocol used is as specified in 8.7.2 GLOFA GM Loader Protocol.

Device	Connection Available Area			Remarks
	Bit	Word	Long	
I Area	%IX0.0.0 - 63.7.63	%IW0.0.0 - 63.7.3	%IW0.0.0 - 63.7.1	
Q Area	%QX0.0.0 - 63.7.63	%QX0.0.0 - 63.7.3	%QX0.0.0 - 63.7.1	
M Area	%MX0 - %MX524272	%MW0-%MW32767	%MW0-%MW32766	
	%MW0.0-%MW32767.15			
S Area	%SX0 - %SX524272	%SW0-%SW32767	%SW0-%SW32766	
	%SW0.0-%SW32767.15			

8.8.3 Connection Diagram

If the Dedicated Protocol is used, the Connection Diagram of XGT Panel and GLOFA GM series is as shown below. Use the Connection Diagram button of PLC Type Change on the Panel Editor to check the Connection Diagram below.

1) CH 1(if connected with RS-232C used)

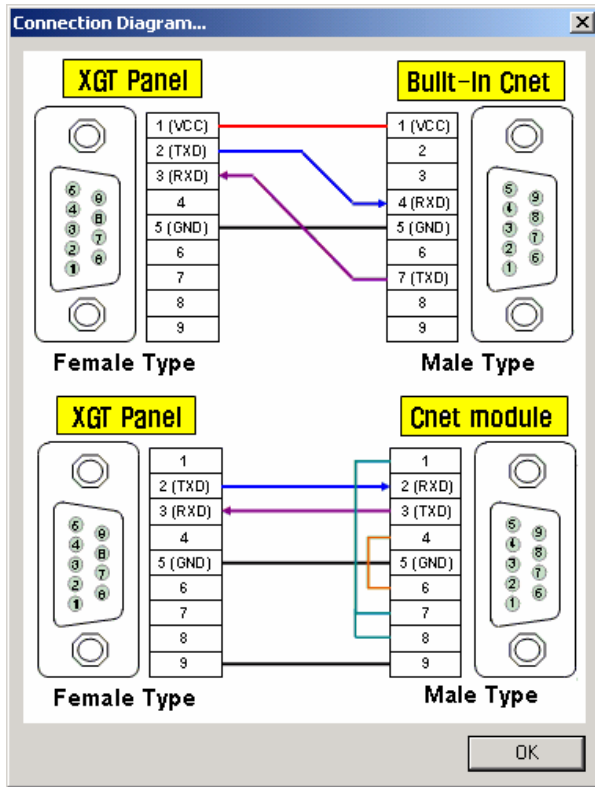

2) CH 2(if connected with RS-422/485 used)

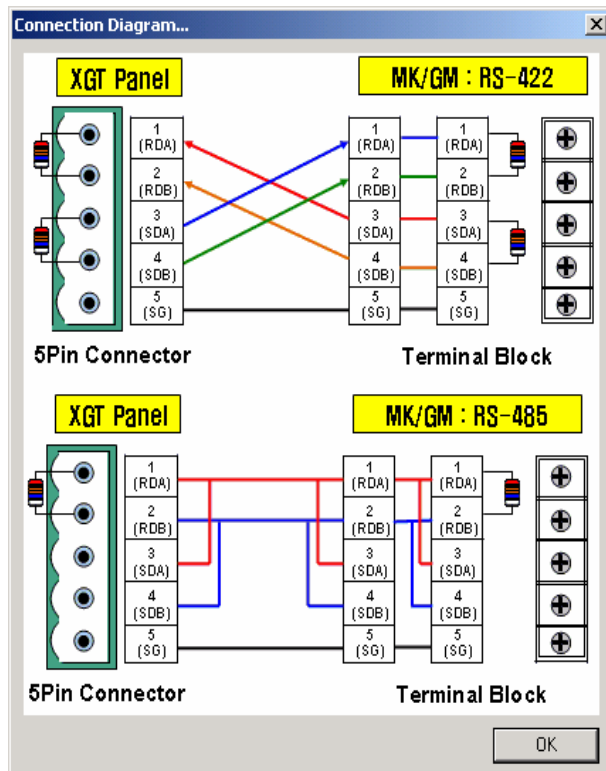

**8.9 LS Inverter : Dedicated Protocol**

**8.9.1 Communication Mode**

Connection is available through the LS inverter and the Dedicated Inverter Protocol.  
 If connected with the LS inverter and the Dedicated Inverter Protocol, its applicable communication setting is as follows.  
 At this moment, the applicable communication setting of the inverter and the XGT Panel to be connected between should be set identical to each other.

Setting Item	Setting Contents		Remarks
	CH 1	CH 2	
Communication Mode	RS-232C	RS-422, RS-485	-
Instrument Sided Connector	Terminal plate or connector		-
Connection Protocol	LS inverter Dedicated Protocol		-
Communication Speed	1,200/2,400/4,800/9,600/19,200bps		
Data Bit	7Bits, 8Bits		
Parity Bit	None, Even Bits, Odd Bits		
Stop Bits	1 Bit, 2 Bits		
Station No.	0 ~ 31		Station No. unavailable if identical to XGT Panel

**8.9.2 Connection Available device**

The range of the connection available device if connected with the Dedicated Inverter Protocol is as shown below.

Device	Connection Available Area			Remarks
	Bit	Word	Long	
-	-	H'0000 –H'FFFF	H'0000 –H'FFFE	Bits Read unavailable

## 8.9.3 Connection Diagram

If the Dedicated Inverter Protocol is used, the Connection Diagram of the XGT Panel and the inverter is as shown below. Use the Connection Diagram button of PLC Type Change on the Panel Editor to check the Connection Diagram below. In case of LS inverters, since the Pin Number of the signal cable is diverse based on the type, refer to the user's manual of the applicable inverter.

1) CH 1 (if connected with RS-232C used)

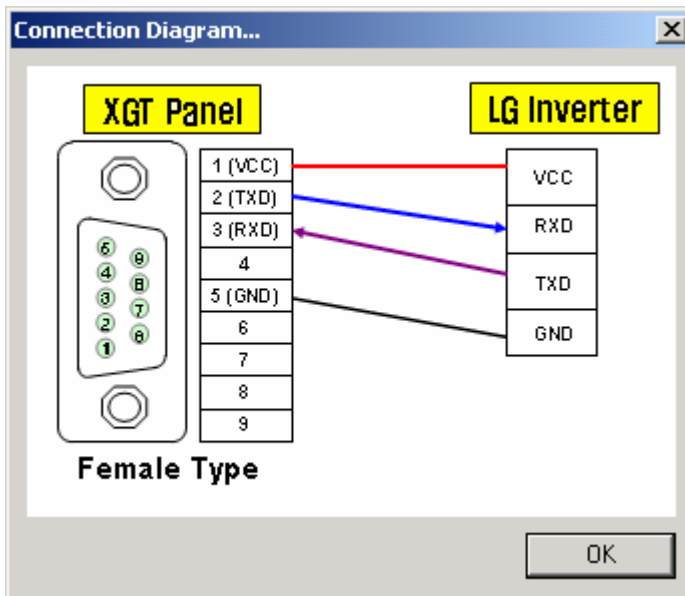

2) CH 2 (if connected with RS-422/485 used)

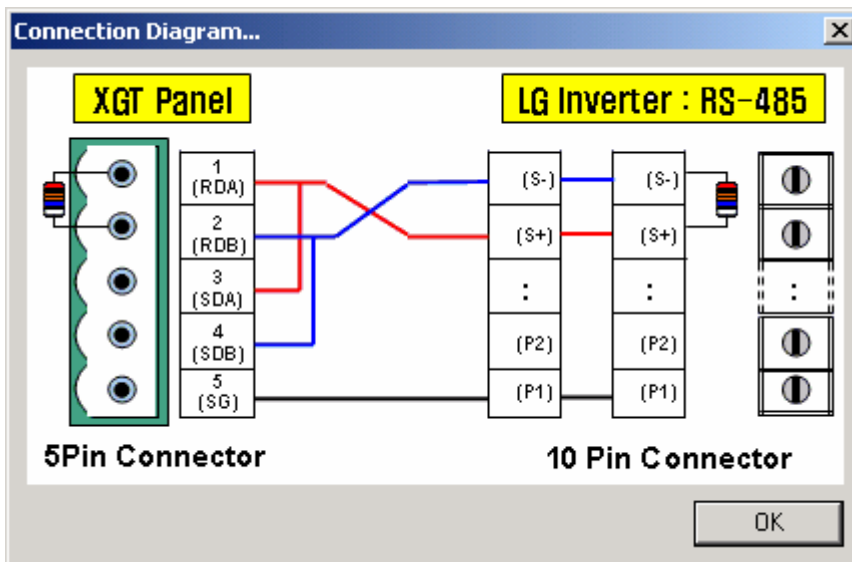

**8.10 MODBUS Protocol**

**8.10.1 Communication Mode**

Connection is available through various instruments and MODBUS Protocol at which MODBUS(RTU/ASC) communication is supported.

If connected with the MODBUS Protocol, its applicable communication setting is as follows.

At this moment, the applicable communication setting of the instrument and the XGT Panel to be connected between should be set identical to each other.

Setting Item	Setting Contents		Remarks
	CH 1	CH 2	
Communication Mode	RS-232C	RS-422, RS-485	-
Instrument Sided Connector	Terminal plate or connector		-
Connection Protocol	MODBUS(RTU/ASC) Protocol		-
Communication Speed	1,200/2,400/4,800/9,600/19,200/38,400/57,600/115,200bps		
Data Bit	7Bits, 8Bits		
Parity Bit	None, Even Bits, Odd Bits		
Stop Bits	1 Bit, 2 Bits		
Station No.	0 ~ 31		Station No. unavailable if identical to XGT Panel

**8.10.2 Connection Available Device**

The range of the connection available device if connected with the MODBUS Dedicated Protocol used is as follows.

Device	Connection Available Area			Remarks
	Available Range	Read (Function Code)	Write (Function Code)	
Output Contact	0 - 65535	Available(01)	Available(05)	
Input Contact	0 - 65535	Available(02)	Available(05)	
Output Register	0 - 65535	Available(03)	Available(06,16)	
Input Register	0 - 65535	Available(04)	Available(06,16)	

**8.10.3 Connection Diagram**

If the MODBUS Protocol is used, the Connection Diagram of the XGT Panel and the connected instrument is as shown below.

Use the Connection Diagram button of PLC Type Change on the Panel Editor to check the Connection Diagram below.

In case of the MODBUS Protocol, since the Pin Number of the signal cable is diverse based on the type of the applicable instrument connected, refer to the user's manual of the instrument.

- 1) CH 1 (if connected with RS-232C used)

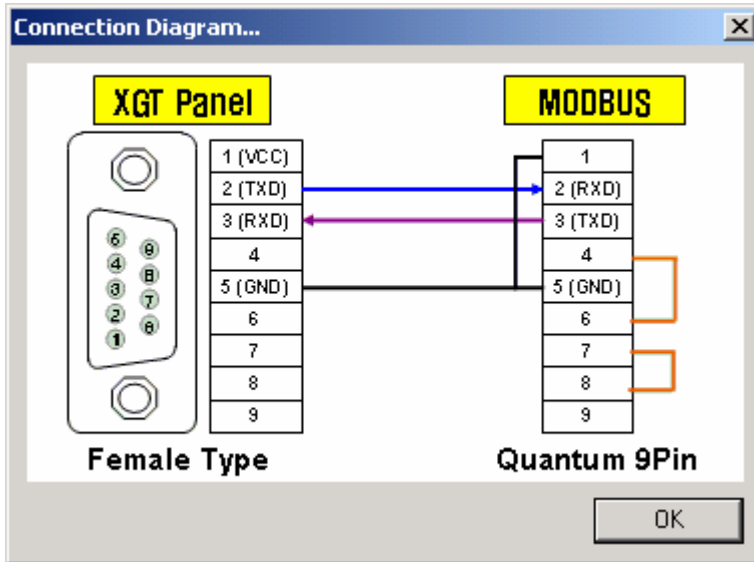

- 2) CH 2 (if connected with RS-422/485 used)

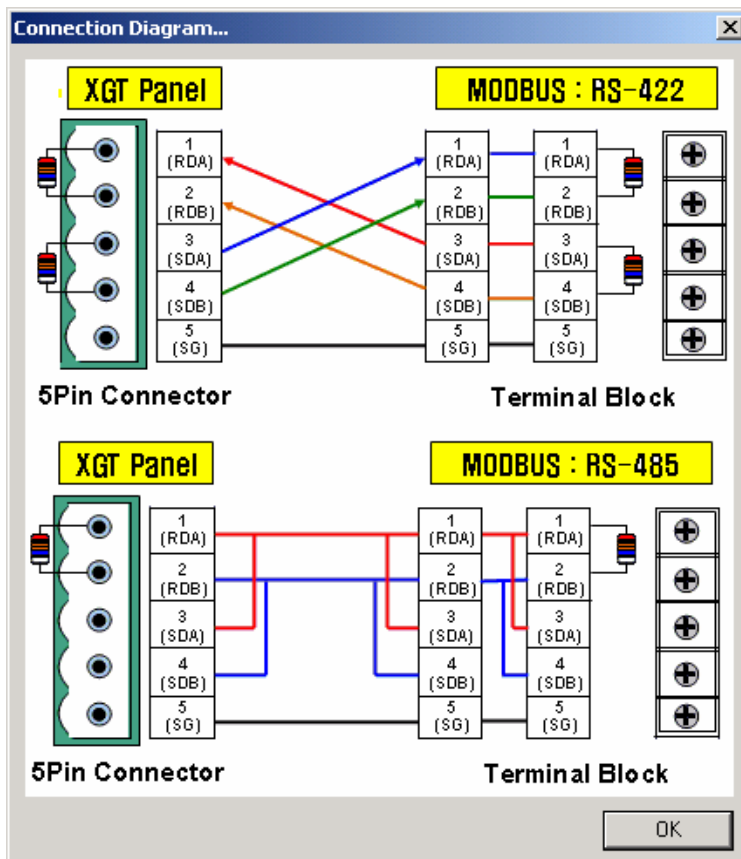

### 8.11 Mitsubishi Melsec FX series : Link Protocol

#### 8.11.1 Communication Mode

Connection is available through the Link Protocol of Mitsubishi FX series.

If connected with Mitsubishi FX, its applicable communication setting is as follows.

At this moment, the applicable communication setting of FX series and the XGT Panel to be connected between should be set identical to each other.

Setting Item	Setting Contents		Remarks
	CH 1	CH 2	
Communication Mode	RS-232C	RS-422, RS-485	-
Instrument Sided Connector	9-Pin/25-pin connector	8-Pin Mini DIN/5Pin connector	-
Connection Protocol	Computer Link(Dedicated Protocol)		-
Communication Speed	300/600/1,200/2,400/4,800/9,600/19,200bps		
Data Bit	7Bits, 8Bits		
Parity Bit	None, Even Bits, Odd Bits		
Stop Bits	1 Bit, 2 Bits		
Station No.	0 ~ 15		Station No. unavailable if identical to XGT Panel

#### 8.11.2 Connection Available Device

The device range of the Read/Write available FX series of PLC with the XGT Panel connected is as shown below.

Max. range of the connection available device is diverse based on the connected type of PLC.

Max. available range is displayed in here. For more information on the Max. device range of each PLC, refer to the user's manual of the applicable PLC.

At this time, the address increment is octonary for X and Y areas, and decimal for the other areas. Refer to the user's manual of the applicable PLC for more information.

Device	Connection Available Area			Remarks
	Bit	Word	Long	
X Area	X000 – X357	X000 – X340	X000 – X320	Ex.) X007 : X0's bit 7
Y Area	Y000 – Y357	Y000 – Y340	Y000 – Y320	
S Area	S0 –S4095	S0 –S4080	S0 –S4064	
M Area	M0000 –M8511	M0000 –M8496	M0000 –M8480	
D Area	-	D0000 –D8511	D0000 – D8510	
T Area	-	T000 – T511	T000 – T510	
C Area	-	C000 – C255	C000 – C254	

**8.11.3 Connection Diagram**

If connected with FX series, the Connection Diagram of the XGT Panel and the connected instrument is as shown below. Use the Connection Diagram button of PLC Type Change on the Panel Editor to check the Connection Diagram below.

1) CH 1 (if connected with RS-232C used)

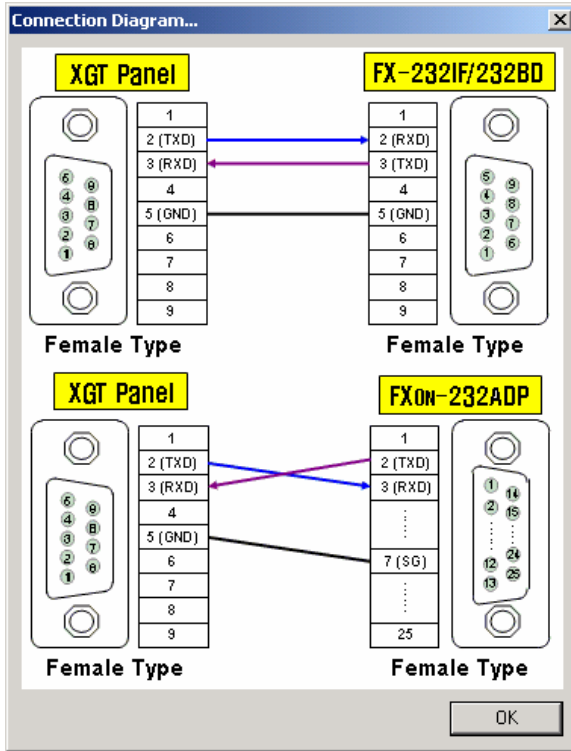

2) CH 2 (if connected with RS-422/485 used)

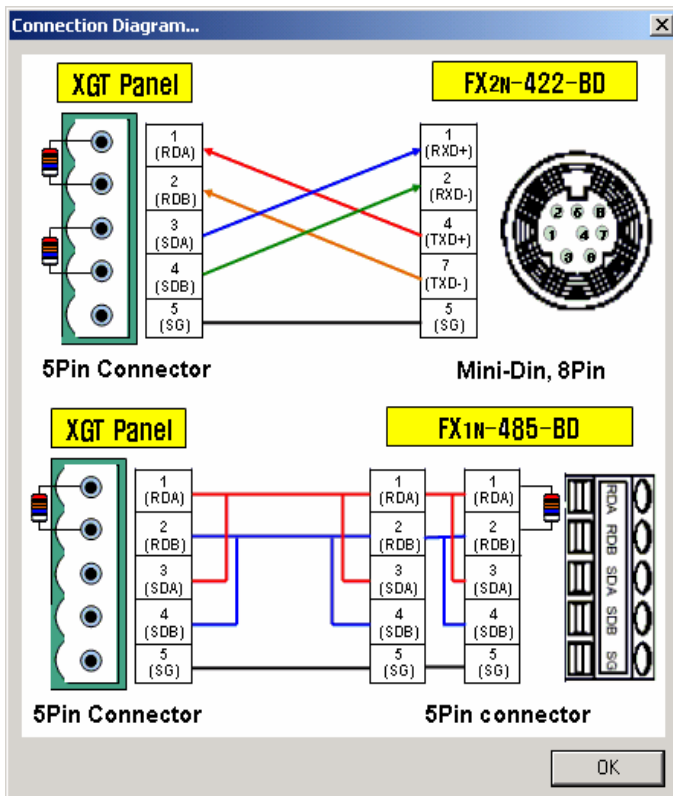



### 8.12 OMRON CPM : C- Mode Protocol

#### 8.12.1 Communication Mode

Connection is available through the C-mode Protocol of Omron CPM series.

If connected with CPM series, its applicable communication setting is as follows.

At this moment, the applicable communication setting of CPM series and the XGT Panel to be connected between should be set identical to each other.

Setting Item	Setting Contents		Remarks
	CH 1	CH 2	
Communication Mode	RS-232C	RS-422, RS-485	-
Instrument Sided Connector	9-Pin male connector	5-Pin connector	-
Connection Protocol	C Mode protocol		-
Communication Speed	1,200/2,400/4,800/9,600/19,200bps		
Data Bit	7Bits, 8Bits		
Parity Bit	None, Even Bits, Odd Bits		
Stop Bits	1 Bit, 2 Bits		
Station No.	0 ~ 31		Station No. unavailable if identical to XGT Panel

#### 8.12.2 Connection Available device

The range of the Read/Write available device with the XGT Panel connected is as shown below.

Max. range of the connection available device is diverse based on the connected type of PLC.

Max. available range is displayed in here. For more information on the Max. device range of each PLC, refer to the user's manual of the applicable PLC.

Device	Connection Available Area			Remarks
	Bit	Word	Long	
CIO Area	CIO0.0 –CIO6143.15	CIO0 –CIO6143	CIO0 –CIO6142	
LR Area	LR0.0 –LR199.15	LR0 –LR199	LR0 – LR198	
HR Area	HR0.0 –HR511.15	HR0 –HR511	HR0 –HR510	
T/C Area	-	T/C0 - 4095	T/C0 – 4094	
DM Area	-	DM0000 –DM9999	DM0000 – DM9998	
AR Area	-	AR000 –AR959	AR000 – AR958	

**8.12.3 Connection Diagram**

If connected with Omron series, the Connection Diagram of the XGT Panel and the connected instrument is as shown below. Use the Connection Diagram button of PLC Type Change on the Panel Editor to check the Connection Diagram below.

1) CH 1 (if connected with RS-232C used)

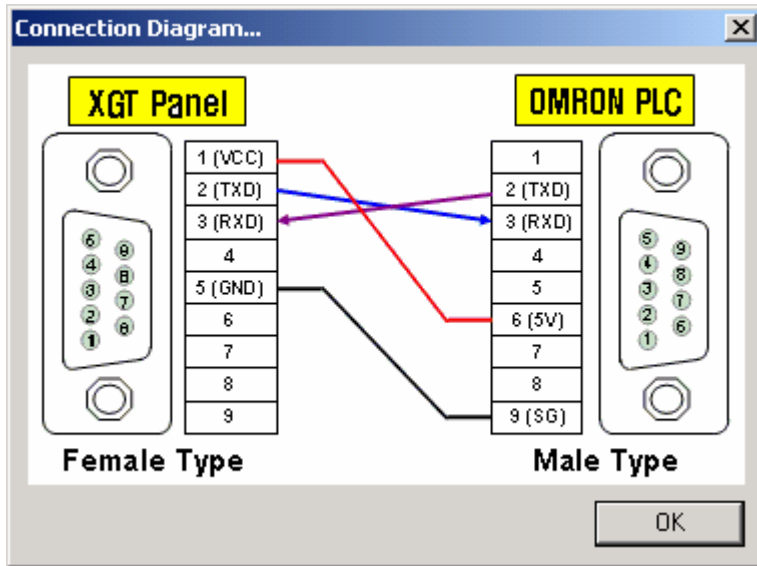

2) CH 2 (if connected with RS-422/485 used)

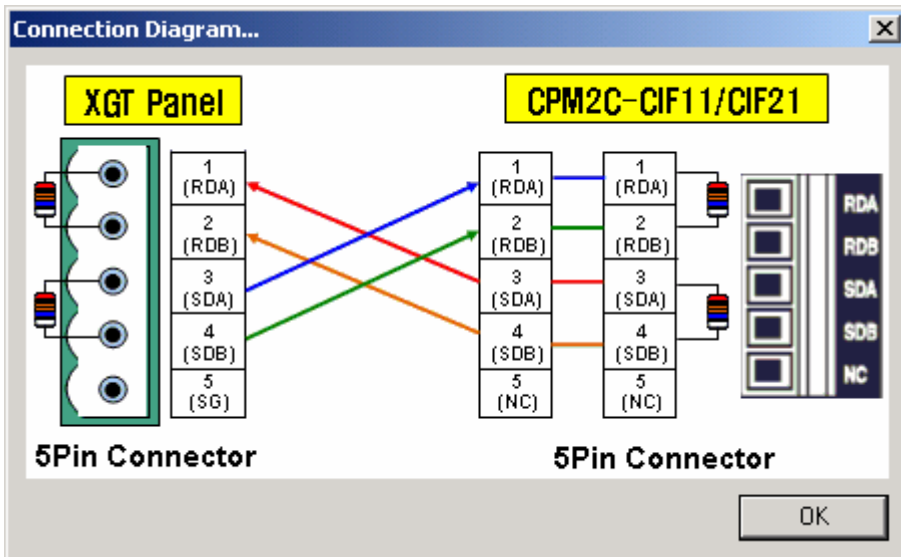

**8.13 Koyo Direct Logic06 : DirectNet**

**8.13.1 Communication Mode**

Connection is available through Direct Logic 06 and DirectNet of Koyo.  
 If connected with Direct Logic 06, its applicable communication setting is as follows.  
 At this moment, the applicable communication setting of DL06 and the XGT Panel to be connected between should be set identical to each other.

Setting Item	Setting Contents		Remarks
	CH 1	CH 2	
Communication Mode	RS-232C	RS-422, RS-485	-
Instrument Sided Connector	RJ-12 Phone Plug	15-Pin SVGA D-Sub	-
Connection Protocol	Direct Net protocol		-
Communication Speed	9,600bps(fixed)	300/600/1,200/2,400/9,600/19,200/38,400bps	
Data Bit	8Bits		
Parity Bit	Odd (fixed)	None, Odd, Even	
Stop Bits	1 Bit		
Station No.	1 (fixed)	1 ~ 31	

**8.13.2 Connection Available Device**

The range of the Read/Write available device with the XGT Panel connected is as shown below.  
 For more information on the device address, refer to the user's manual of the applicable PLC.

Device	Connection Available Area			Remarks
	Bit	Word	Long	
X Area	X0 -X777	X0 - X37	X0 - X36	
Y Area	Y0 -Y777	Y0 - Y370	Y0 - Y36	
C Area	C0 -C1777	C0 - C77	C0 - C76	
SP Area	SP0 -SP777	SP0 - SP37	SP0 - SP36	
T Area	T0 - T377	T0 - T377	T0 - T376	
CT Area	CT0 - CT177	CT0 - CT177	CT0 - CT176	
S Area	S0 - S1777	S0 -S77	S0 -S76	
GX Area	GX0 - GX3777	GX0 - GX177	GX0 - GX176	
GY Area	GY0 - GY3777	GY0 - GY177	GY0 - GY176	
V Area	-	V0 - V41237	V0 - V41236	

**8.13.3 Connection Diagram**

If connected with DL06 series, the Connection Diagram of the XGT Panel and the connected instrument is as shown below. Use the Connection Diagram button of PLC Type Change on the Panel Editor to check the Connection Diagram below.

1) CH 1 (if connected with RS-232C used)

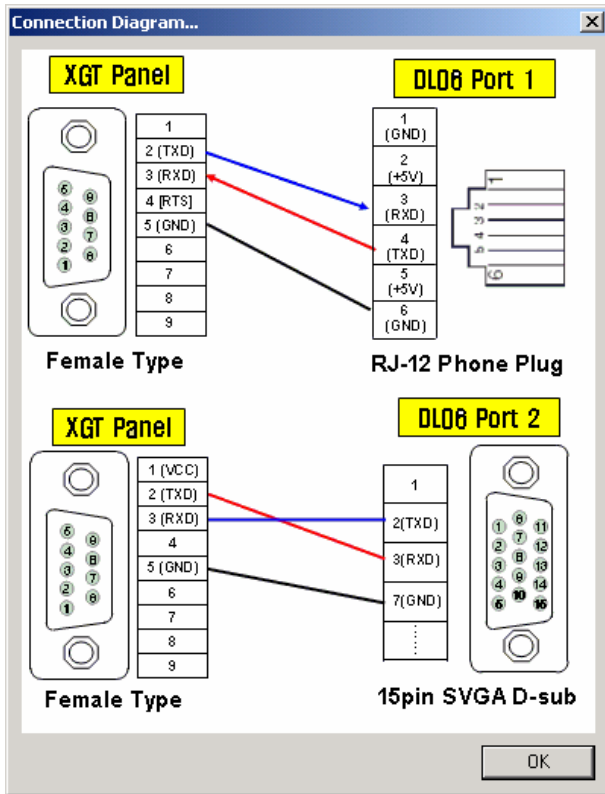

2) CH 2 (if connected with RS-422/485 used)

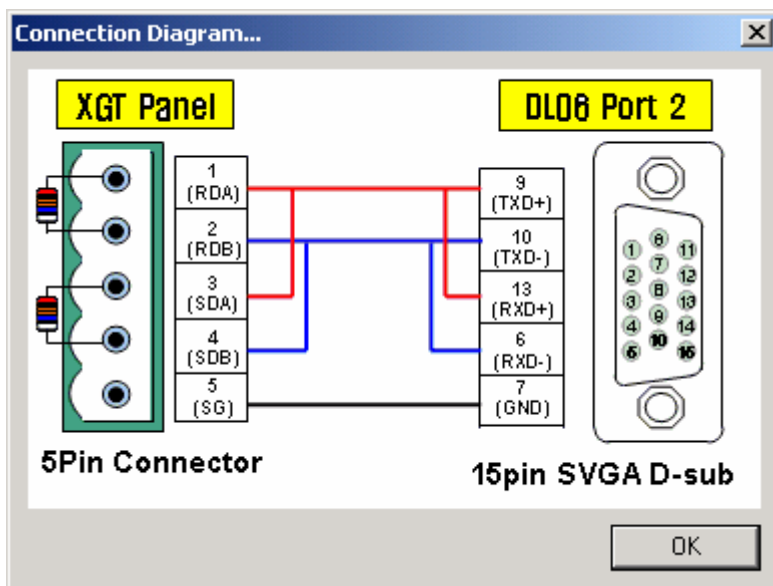

**8.14 NAIS FP series : Mewtocol**

**8.14.1 Communication Mode**

Connection is available through FP series of PLC and Mewtocol of NAIS.  
 If connected with FP series, its applicable communication setting is as follows.  
 At this moment, the applicable communication setting of FP series and the XGT Panel to be connected between should be set identical to each other.

Setting Item	Setting Contents		Remarks
	Tool Port	CH1/CH 2	
Communication Mode	RS-232C	RS-232C,RS-422, RS-485	-
Instrument Sided Connector	Mini Din 5-Pin connector	5-Pin connector	-
Connection Protocol	Mewtocol		-
Communication Speed	9,600bps(fixed)	2,400/9,600/19,200/38,400/57,600/115,200bps	
Data Bit	8Bits	7Bits, 8Bits	
Parity Bit	Odd (fixed)	None, Odd, Even	
Stop Bits	1 Bit	1 Bit, 2Bits	
Station No.	1 ~ 31	1 ~ 31	

**8.14.2 Connection Available Device**

The range of the Read/Write available device with the XGT Panel connected is as shown below.  
 Max. range of the connection available device is diverse based on the connected type of PLC.  
 Max. available range is displayed in here. For more information on the Max. device range of each PLC, refer to the user's manual of the applicable PLC.

Device	Connection Available Area			Remarks
	Bit	Word	Long	
X Area	X0 -X73F	WX0 - WX73	DWX0 - DWX72	
Y Area	Y0 -Y73F	WY0 - WY73	DWY0 - DWY72	
R Area	R0 -R97F	WR0 -WR97	DWR0 -DWR96	
L Area	L0 -L63F	WL0 - WL63	DWL0 - DWL62	
T Area	T0 - T1023	EV0 - EV1023	DEV0 -DEV1022	
C Area	C0 - C1023			
D Area	-	DT0 -DT32764	DDT0 -DDT32763	
R(Special)	R9000 -R910F	-	-	
LD Area	-	LD0 -LD127	DLD0 -DLD126	
D(Special)	-	DT90000 - 90259	DDT90000 - 90258	

**8.14.3 Connection Diagram**

If connected with NAIS FP series, the Connection Diagram of the XGT Panel and the connected instrument is as shown below.

Use the Connection Diagram button of PLC Type Change on the Panel Editor to check the Connection Diagram below.

1) CH 1 (if connected with RS-232C used)

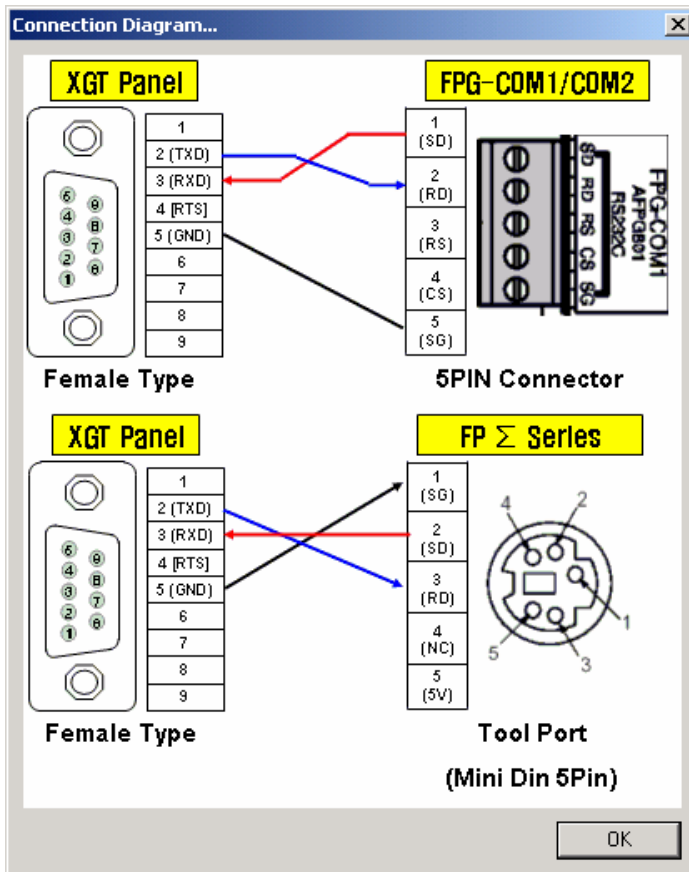

2) CH 2 (if connected with RS-422/485 used)

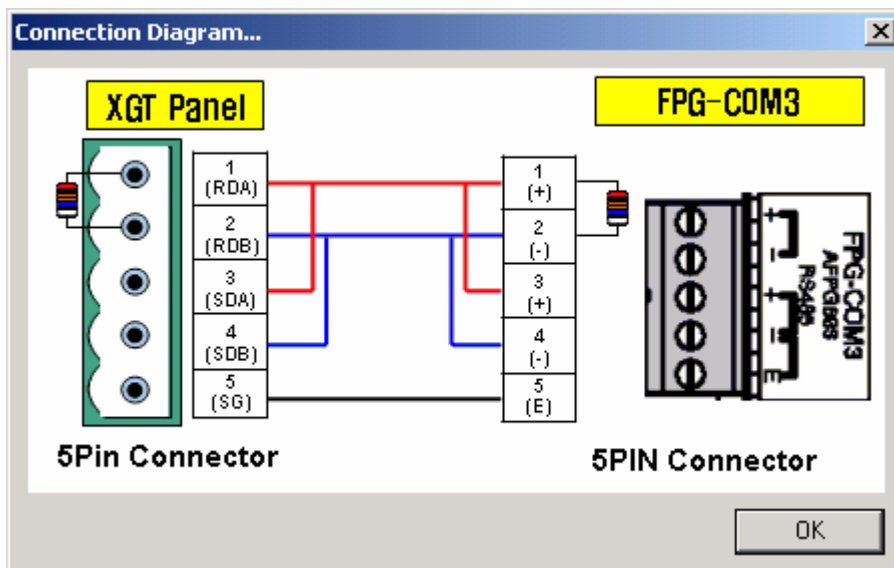

**8.15 Siemens S7-200 series : PPI Protocol**

**8.15.1 Communication Mode**

Connection is available through Siemens S7-200 series of PLC and PPI Protocol.  
 If connected with S7-200 series, its applicable communication setting is as follows.  
 At this moment, the applicable communication setting of S7-200 series and the XGT Panel to be connected between should be set identical to each other.

Setting Item	Setting Contents	Remarks
	Ch2	
Communication Mode	RS-485	Ch1 Unavailable
Instrument Sided Connector	9-Pin connector	
Connection Protocol	PPI Protocol	
Communication Speed	9,600/19,200bps	
Data Bit	8Bits	
Parity Bit	Even	
Stop Bits	1 Bit	
Station No.	1 ~ 31	

**8.15.2 Connection Available device**

The range of the Read/Write available device with the XGT Panel connected is as shown below.  
 Max. range of the connection available device is diverse based on the connected type of PLC.  
 Max. available range is displayed in here. For more information on the Max. device range of each PLC, refer to the user's manual of the applicable PLC.

Device	Connection Available Area			Remarks
	Bit	Word	Long	
I Area	I0.0 -I15.7	IW0 - IW14	ID0 -ID12	
Q Area	Q0.0 -Q15.7	QW0 - QW14	QD0 -QD12	
T Area	T0 -T255	TW0 -TW255	-	
C Area	C0 -C255	CW0 -CW255	-	
V Area	V0.0 - V5119.7	VW0 - VW5118	VD0 -VD5116	
M Area	M0.0 - M31.7	MW0 - MW30	MD0 -MD28	
SM Area	SM0.0 - SM299.7	SMW0 - SMW298	SMD0 -SMD296	

### 8.15.3 Connection Diagram

If connected with S7-200 series, the Connection Diagram of the XGT Panel and the connected instrument is as shown below. Use the Connection Diagram button of PLC Type Change on the Panel Editor to check the Connection Diagram below.

1) CH 2(if connected with RS-485used)

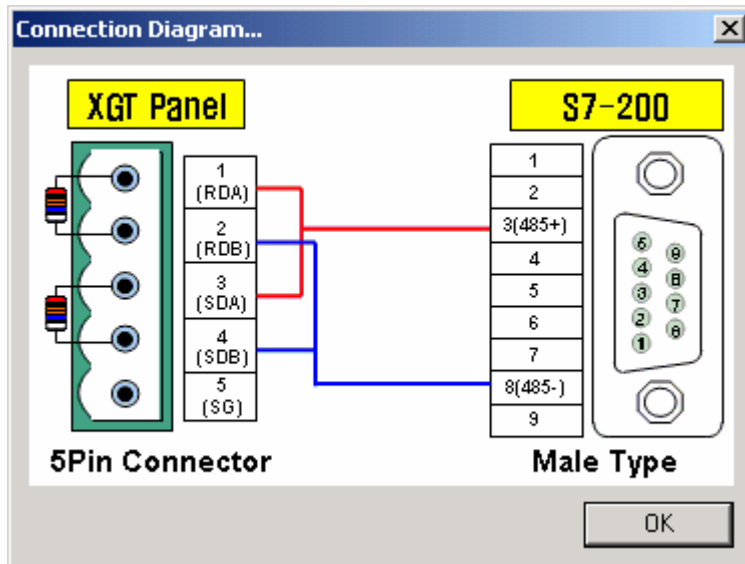



### 8.16 Fuji Inverter FVR-E11S

#### 8.16.1 Communication Mode

Connection is available with Fuji Inverter FVR-E11S.

If connected with FVR-E11S, its applicable communication setting is as follows.

At this moment, the applicable communication setting of the inverter and the XGT Panel to be connected between should be set identical to each other.

Setting Item	Setting Contents	Remarks
	Ch2	
Communication Mode	RS-485	Ch1 Unavailable
Instrument Sided Connector	RJ45 connector	
Connection Protocol	Fuji Inverter Protocol	
Communication Speed	1,200/2,400/4,800/9,600/19,200bps	
Data Bit	8Bits, 7Bits	
Parity Bit	None, Odd, Even	
Stop Bits	1 Bit, 2 Bits	
Station No.	1 ~ 31	

#### 8.16.2 Connection Available device

The Function Code Area with Read/Write available with the XGT Panel connected is as shown below.

Max. range of the connection available device is diverse based on the connected type of PLC.

Max. available range is displayed in here. For more information on the Max. device range of each PLC, refer to the user's manual of the applicable PLC.

Device	Connection Available Area			Remarks
	Bit	Word	Long	
F Area	-	F0 – F42	-	
E Area	-	E1 – E42	-	
C Area	-	C1 – C33	-	
P Area	-	P1 – P10	-	
H Area	-	H1 – H46	-	
A Area	-	A1 – A19	-	
M Area	-	M1 – M48	-	
S Area	-	S1 – S11	-	

### 8.16.3 Connection Diagram

If connected with FVR-E11S, the Connection Diagram of the XGT Panel and the connected instrument is as shown below. Use the Connection Diagram button of PLC Type Change on the Panel Editor to check the Connection Diagram below.

1) CH 2(if connected with RS-485 used)

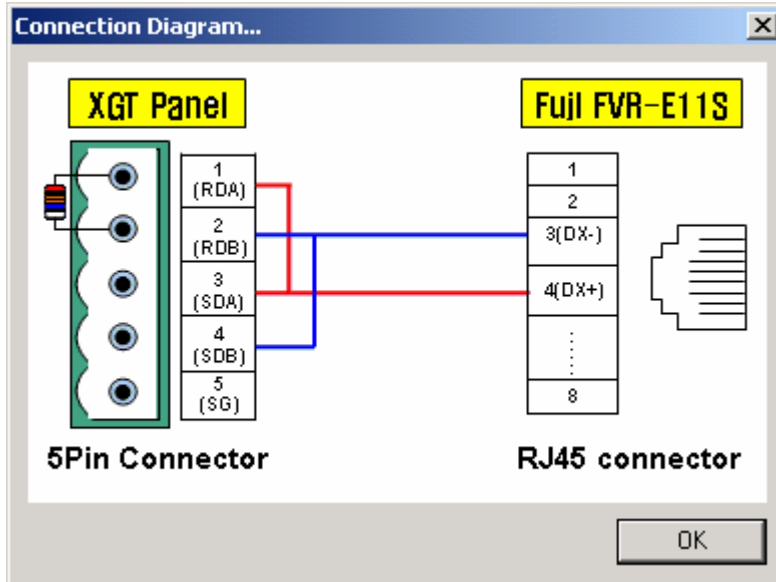

# Chapter 9. Installation and Wiring

## 9.1 Installation

### 9.1.1 Installation Environment

This unit has high reliability regardless of its installation environment, but be sure to check the following for system reliability.

#### 1) Environment requirements

Avoid installing this unit in locations which are subjected or exposed to:

- (1) Water leakage and dust.
- (2) Continuous shocks or vibrations.
- (3) Direct sunlight.
- (4) Dew condensation due to rapid temperature change.
- (5) Higher or lower temperatures outside the range of 0 to 55 °C
- (6) Relative humidity outside the range of 5 to 95 %
- (7) Corrosive or flammable gases

#### 2) Precautions during installing

- (1) During drilling or wiring, do not allow any wire scraps to enter into the XGT Panel.
- (2) Install it on locations that are convenient for operation.
- (3) Make sure that it is not located on the same panel that high voltage equipment located.
- (4) Make sure that the distance from the walls of duct and external equipment be 50mm or more.

#### 3) Heat protection design of control box

- (1) When installing the XGT Panel in a closed control box, be sure to design heat protection of control box with consideration of the heat generated by the XGT Panel itself and other devices. The circulation of air using a ventilation fan might affect to the XGT Panel caused by an inflow of gas or dust.
- (2) It is recommended that filters or closed heat exchangers be used.

### 9.1.2 Handling Instructions

This section describes the handling of the XGT Panel.

- Do not drop off, and make sure that strong shock should not be applied.
- Do not unload the PCB from its case. It can cause faults.
- During wiring, be sure to check any foreign matter like wire scraps should not enter into the upper side of the PLC. If any foreign matter has entered into it, always eliminate it.

#### 1) Handling instructions

The followings describe instructions for handling or installing the XGT Panel.

##### (1) I/O specifications re-check

Re-check the input voltage and polarity for the input part. If a voltage over the maximum switching capacity is applied, it might cause a problem, breakdown or fire. Do not exceed 10m for the wiring.

##### (2) Used wire

Select the wire with due consideration of ambient temperature and rated current. Its minimum specifications should be AWG24 (0.18 mm<sup>2</sup>) or more.

##### (3) Environment

When wiring the I/O part, if it locates near a device generating an cause short circuit, destruction or malfunction.

##### (4) Polarity

Before applying the power to part that has polarities, be sure to check its polarities.  
Especially, be sure not to connect AC power supply to the external power supply terminal.

##### (5) Terminal block

Check its fixing. During drilling or wiring, do not allow any wire scraps to enter the PLC. It can cause malfunction and fault.

##### (6) Wiring

Wiring I/O wires with high voltage cable or power supply line can cause malfunction or disorder.  
Be sure that any wire does not pass across the LCD (I/O status will not be clearly identified).

##### (7) Be cautious that strong shock does not applied to the XGT Panel, and do not separate the PCB from the case.

## Chapter 9. Installation and Wiring

---

### 2) Mounting instructions

The following explains instructions for mounting the XGT PLC onto the control panel.

- (1) Allow sufficient distance from upper part of the unit for easy module replacement and ventilation.
- (2) Do not mount the base board together with a large-sized electromagnetic contact or no-fuse breaker, which produces vibration, on the same panel. Mount them on different panels, or keep the unit away from such a vibration source
- (3) Mount the wire duct as it is needed.
  - If the wire duct is mounted on the upper part of the PLC, make the wiring duct clearance 50 mm or less for good ventilation. Also, allow the distance enough to press the hook in the upper part from the upper part of the PLC.
  - If the wire duct is mounted on the lower part of the PLC, make optic or coaxial cables contact it and consider the minimum diameter of the cable.

## Chapter 9. Installation and Wiring

### 9.2 Wiring

The followings explain the wiring instructions for use of the system.

#### 9.2.1 Power Supply Wiring

(1) To protect the PLC from noise, twist the power line as densely as possible, and keep the shortest distance.

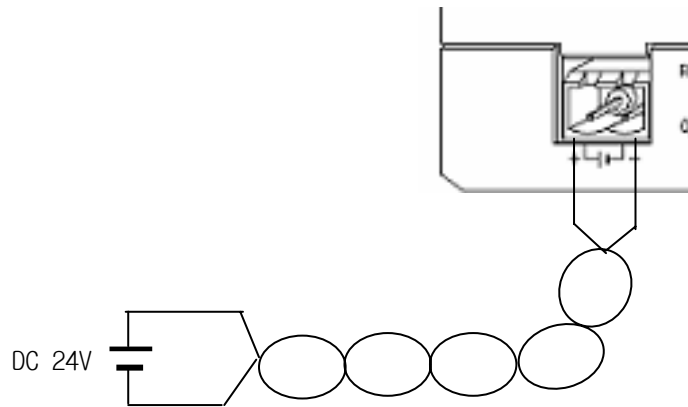

- (2) Connect a power supply that has less noise (if there are lots of noise, connect noise filter).
- (3) When wiring, separate the PLC power supply from those for I/O and power device as shown below.
- (4) To minimize voltage drop, use the thickest (max. 2 mm<sup>2</sup>) wires possible
- (5) Do not bundle the 24VDC cable with main-circuit (high voltage, large current) wires or the I/O signal wires.  
If possible, provide more than 80 mm distance between the cables and wires.

## Chapter 9. Installation and Wiring

(6) As a measure against very large surge (e.g. due to lightning), connect a surge absorber as shown below.

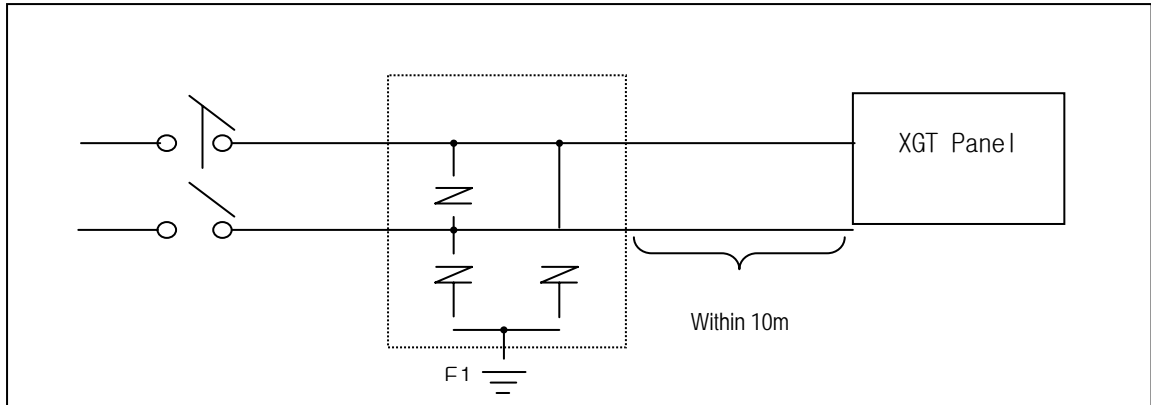

Surge absorber for lightning

- (7) Use an insulating transformer or noise filter against noise.
- (8) Do not allow the transformer or noise filter across the duct.

### 9.2.2 Cable Specifications for Wiring

The specifications for wiring are as follow:

Kinds of external connection	Cable Specifications (mm <sup>2</sup> )	
	Minimum	Maximum
Digital Input	0.18 (AWG24)	1.5 (AWG16)
Digital Output	0.18 (AWG24)	2.0 (AWG14)
Analog Input / Output	0.18 (AWG24)	1.5 (AWG16)
Communication	0.18 (AWG24)	1.5 (AWG16)
Main power	1.5 (AWG16)	2.5 (AWG12)
Grounding	1.5 (AWG16)	2.5 (AWG12)

## Chapter 10. Maintenance

Be sure to perform daily and periodic maintenance and inspection in order to maintain the PLC in the best conditions.

### 10.1 Maintenance and Inspection

The internal circuit of the XGT Panel mainly consist of semiconductor devices and its service life is semi-permanent. However, periodic inspection is requested for ambient environment may cause damage to the devices. When inspecting one or two times per six months, check the following items.

Check Items		Judgment	Countermeasure
Ambient environment	Temperature	0 ~ + 55°C	Adjust the operating temperature and humidity with the defined range.
	Humidity	5 ~ 95%RH	
	Vibration	No vibration	Use vibration resisting rubber or the vibration prevention method.
Shaking of the XGT Panel		No shaking allowed	Fix the XGT Panel
Screws connecting conditions		No loose allowed	Retighten terminal screws.
Change rate of input voltage		- 15% to 10%	Hold it with the allowable range.
Spare parts		Check the number of Spare parts and their Store conditions	Cover the shortage and improve the conditions.

### 10.2 Daily Inspection

The following table shows the inspection and items which are to be checked daily.

Check Items	Check Points	Judgment	Countermeasure
Terminal block connecting conditions	Check for loose mounting screws	Screws should not be loose	Retighten Screws
Communication connector connecting conditions	Check the connector falling	Connectors should be fixed	Retighten Screws



## Chapter 10. Maintenance

### 10.3 Periodic Inspection

Check the following items once or twice every six months, and perform the needed corrective actions.

Check Items		Checking Methods	Judgment	Countermeasure
Ambient Environment	Ambient temperature	- Measure with thermometer and hygrometer	0 ~ 55 °C	Adjust to general standard (Internal environmental standard of control section)
	Ambient Humidity		5 ~ 95%RH	
	Ambience	- Measure corrosive gas	There should be no corrosive gases	
XGT Panel Conditions	Looseness, Ingress	Move the XGT Panel	The module should be mounted securely.	Retighten screws
	dust or foreign material	Visual check	No dust or foreign material	
Connecting conditions	Loose terminal screws	Re-tighten screws	Screws should not be loose	Retighten
	Loose connectors	Visual check	Connectors should not be loose.	Retighten connector mounting Screws
Line voltage check		Measure voltage between input terminals	10.2 ~ 28.8V DC	Change supply power

## Appendix 1. System Memory

### Appendix 1. System Memory

Address	Name	Description	Remark
0~899	User memory		
900	RTC_C_Y	Year of RTC	BCD
901	RTC_MON	Month of RTC	BCD
902	RTC_DAY	Day of RTC	BCD
903	RTC_HOUR	Hour of RTC	BCD
904	RTC_MIN	Minute of RTC	BCD
905	RTC_SEC	Second of RTC	BCD
906	RTC_WEEK	The day of week (Sunday: 0 – Saturday: 6)	BCD
907	SCAN_MIN	Stores the minimum scan time.	ms
908	SCAN_MAX	Stores the maximum scan time.	ms
909	SCAN_CUR	Stores the current scan time.	ms
910	HMI_TYPE	Stores the type of XGT Panel (A Type: 0, B Type: 1).	
911	HMI_VER	Stores the version of XGT Panel.	
912	VER_CY	Stores the year of O/S.	
913	VER_MD	Stores the month and date of O/S.	
914	CUR_SCR	Stores the number of current screen.	
915	RESERVED	-	
916	COM1_COUNT	Stores the error count of channel 1.	
917	COM1_ERROR	Stores the current error code of channel 1.	
918	COM2_COUNT	Stores the error count of channel 2.	
919	COM2_ERROR	Stores the current error code of channel 2.	
920	KEY_ESC	Stores the status of ESC key.	LSB
921	KEY_ALM	Stores the status of ALM key.	LSB
922	KEY_UP	Stores the status of ▲ key.	LSB
923	KEY_DOWN	Stores the status of ▼ key.	LSB
924	KEY_LEFT	Stores the status of ◀ key.	LSB
925	KEY_RIGHT	Stores the status of ▶ key.	LSB

## Appendix 1. System Memory

Address	Name	Description	Remark
926	KEY_SET	Stores the status of SET key	LSB
927	KEY_ENT	Stores the status of ENT key	LSB
928	KEY_F1	Stores the status of F1 key	LSB
929	KEY_F2	Stores the status of F2 key	LSB
930	KEY_F3	Stores the status of F3 key	LSB
931	KEY_F4	Stores the status of F4 key	LSB
932	W_ALWAYS_ON	Always On (0x0001)	
933	W_ALWAYS_OFF	Always Off (0x0000)	
934	W_SCAN_TOGGLE	Scan toggle (0x0001 <-> 0xFFFE)	
935	W_FATAL_ERROR	Turns on when a fatal error has occurred	LSB
936	W_LIGHT_ERROR	Turns on when an ordinary error has occurred.	LSB
937	W_ERROR_KIND	Stores the error code	
938	W_RTC_DATA_ERROR	Stores the error code of RTC	
939	W_WDT_COUNT	Not used	
940	W_20MS	20-ms cycle clock	LSB
941	W_100MS	100-ms cycle clock	LSB
942	W_200MS	200-ms cycle clock	LSB
943	W_1S	1-sec cycle clock	LSB
944	W_2S	2-sec cycle clock	LSB
945	W_10S	10-sec cycle clock	LSB
946	W_20S	20-sec cycle clock	LSB
947	W_60S	60-sec cycle clock	LSB
948	WDT_PTR_H	The high address of WDT error	
949	WDT_PTR_L	The low address of WDT error	
950	CALC_L_ERR	The error flag of calculation (divided by zero)	Calculation 0 ~ 15
951	CALC_H_ERR	The error flag of calculation (divided by zero)	Calculation 16~19
952~999	RESERVED	-	

## Appendix 2. Dimension

### Appendix 2. Dimension

#### Appendix 2.1 External Dimension (unit: mm)

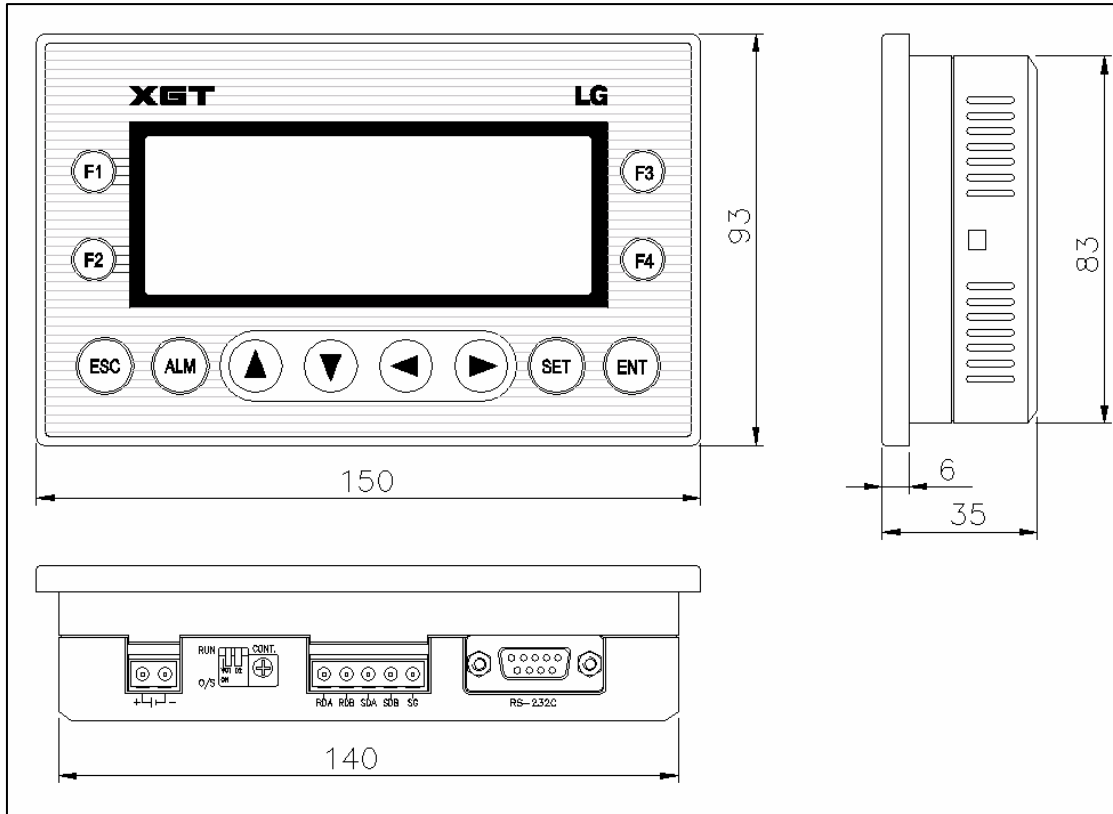

#### Appendix 2.2 Cutting Dimension

